

FRAME SCAFFOLDING CATALOG



DSS 



TABLE OF CONTENTS

PRODUCTS & INFORMATION	PAGE
C-SIZE (YELLOW) FRAMES	4
OPEN END FRAMES, C-SIZE (YELLOW)	5
STEP FRAMES, C-SIZE (YELLOW)	6
C-SIZE (BLUE) FRAMES	7
OPEN END FRAMES, C-SIZE (BLUE)	8
STEP FRAMES, C-SIZE (BLUE)	8
C-SIZE ACCESSORIES	9
C-SIZE BASE COMPONENTS	10
TUBE CROSS BRACES	11
LADDERS AND LADDER BRACKETS	12
PINS	12
SIDE BRACKETS FOR C-SIZE FRAMES	13
ACCESS FOR C-SIZE FRAMES	13
C-SIZE GUARDRAIL SYSTEMS	14
B-SIZE (RED) FRAMES	15
OPEN END FRAMES B-SIZE (RED)	16
STEP FRAMES B-SIZE (RED)	16
NARROW LADDER FRAMES B-SIZE (RED)	17
B-SIZE (BLUE) FRAMES	18
OPEN END FRAMES B-SIZE (BLUE)	19
STEP FRAMES B-SIZE (BLUE)	19
B-SIZE (RED) ACCESSORIES	20
ANGLE IRON CROSS BRACES B-SIZE RED	21
B-SIZE RED ACCESSORIES	22, 23
B-SIZE BASE COMPONENTS	24
B-SIZE GUARDRAIL SYSTEMS	25
B-SIZE (YELLOW) FRAMES	26
OPEN END FRAMES B-SIZE (YELLOW)	27
STEP FRAMES B-SIZE (YELLOW)	27
LADDER FRAMES B-SIZE (YELLOW)	28, 29

World Headquarters: 6059 South Loop East | Houston, TX 77087

Offices In: California | Maryland | Hong Kong | China | United Kingdom | Latin America | Canada



TABLE OF CONTENTS

PRODUCTS & INFORMATION CONT.	PAGE
B-SIZE (YELLOW) ACCESSORIES	30
B-SIZE BASE COMPONENTS	31
TUBE CROSS BRACES	32
LADDERS AND LADDER BRACKETS	33
PINS	33
SIDE BRACKETS FOR C-SIZE FRAMES	34
ACCESS FOR C-SIZE FRAMES	35
B-SIZE GUARDRAIL SYSTEMS	35
MISCELLANEOUS STOCK FRAMES AND ACCESSORIES	36
MISCELLANEOUS STOCK FRAMES (C-SIZE)	37
MISCELLANEOUS STOCK ACCESSORIES	37
MISCELLANEOUS STOCK FRAMES (B-SIZE)	38
CANADA FRAMES AND ACCESSORIES	39
B-SIZE CANADA FRAMES	40
C-SIZE CANADA FRAMES	41
UTILITY SCAFFOLD	42
UTILITY SCAFFOLD	43
PLANKS, DECKS AND BOARDS	44
BOARDS AND DECKS	45
WOOD PLANK	46
UNIVERSAL ACCESSORIES	47
UNIVERSAL ACCESSORIES	48

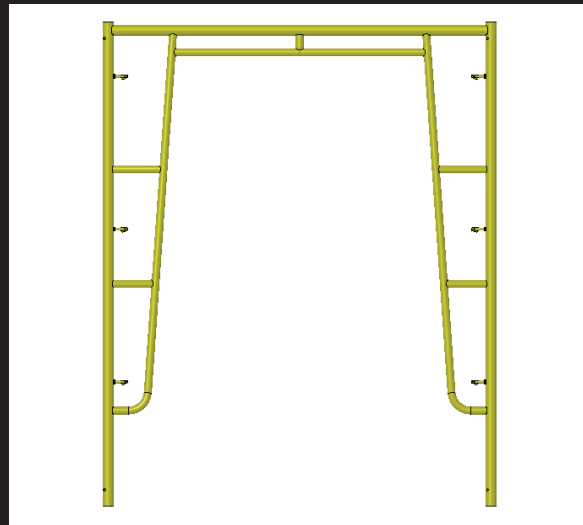

C-Size (Yellow) Frames

World Headquarters: 6059 South Loop East | Houston, TX 77087

Offices In: California | Maryland | Hong Kong | China | United Kingdom | Latin America | Canada

OPEN END FRAMES, C-SIZE (YELLOW)

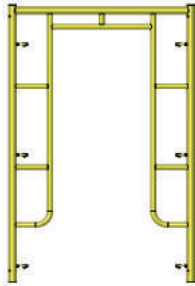

C-FO3W5H-Q48
3'x5' Open End Frame
1.69", Q-Lk 48" Spacing
36.4 lbs.

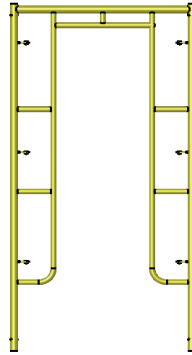

C-FO3W64H-Q48
3'x6'4" Open End Frame
1.69", Q-Lk 48" Spacing
41.3 lbs.

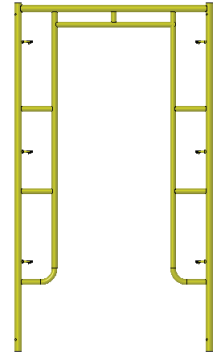

C-FO42W64H-Q48
42"x6'4" Open End Frame
1.69", Q-Lk 48" Spacing
42.3 lbs.

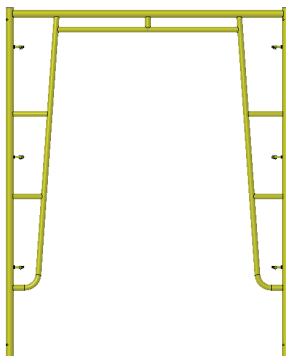

C-FO5W64H-Q48
5'x6'4" Open End Frame
1.69", Q-Lk 48" Spacing
44.8 lbs.

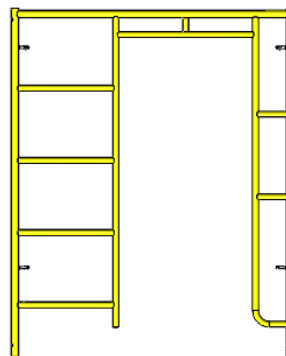

C-FOL5W64H-Q48
5'x6'4" Open End Ladder Frame
1.69", Q-Lk 48" Spacing
50.8 lbs.

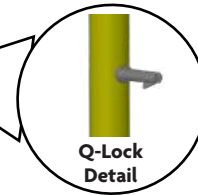

Q-Lock
Detail



PN-CPC
9" C-size Coupling Pin
w/ 1" Collar
1.25 lbs.

C-Size Frame Information

- 1.69" (1-11/16") OD Leg Tube, 13 Gauge
- Uses PN-CPC Coupling Pin
- Standard Color Yellow
- First lock 8.5" from top of frame leg
- Q-Locks
- Spring Retainer hole drilled at 45 degrees

World Headquarters: 6059 South Loop East | Houston, TX 77087

Offices In: California | Maryland | Hong Kong | China | United Kingdom | Latin America | Canada

STEP FRAMES, C-SIZE (YELLOW)

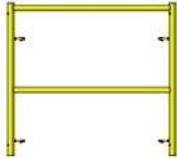

C-FS3W3H-Q24
3'x3' Step Frame
1.69", Q-Lk 24" Spacing
26.1 lbs.



C-FS42W3H-Q24
42"x3' Step Frame
1.69", Q-Lk 24" Spacing
26.8 lbs.

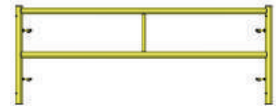

C-FS5W2H-Q12
5'x2' Step Frame
1.69", Q-Lk 12" Spacing
23.5 lbs.

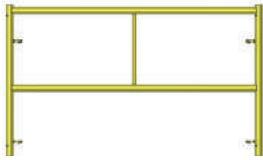

C-FS5W3H-Q24
5'x3' Step Frame
1.69", Q-Lk 24" Spacing
27.8 lbs.

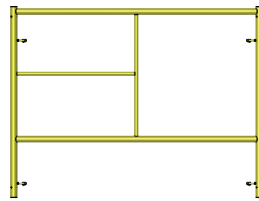

C-FS5W4H-Q36
5'x4' Step Frame
1.69", Q-Lk 24" Spacing
31.8 lbs.

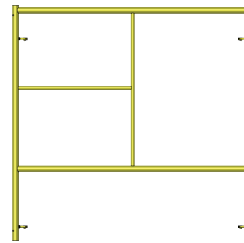

C-FS5W5H-Q48
5'x5' Step Frame
1.69", Q-Lk 48" Spacing
37.1 lbs.

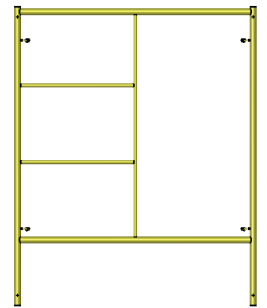

C-FS5W64H-Q48
5'x6'4" Step Frame
1.69", Q-Lk 48" Spacing
44.4 lbs.



PN-CPC
9" C-size Coupling Pin
w/ 1" Collar
1.25 lbs.

C-Size Frame Information

- 1.69" (1-11/16") OD Leg Tube, 13 Gauge
- Uses PN-CPC Coupling Pin
- Standard Color Yellow
- First lock 8.5" from top of frame leg
- Q-Locks
- Spring Retainer hole drilled at 45 degrees

World Headquarters: 6059 South Loop East | Houston, TX 77087

Offices In: California | Maryland | Hong Kong | China | United Kingdom | Latin America | Canada

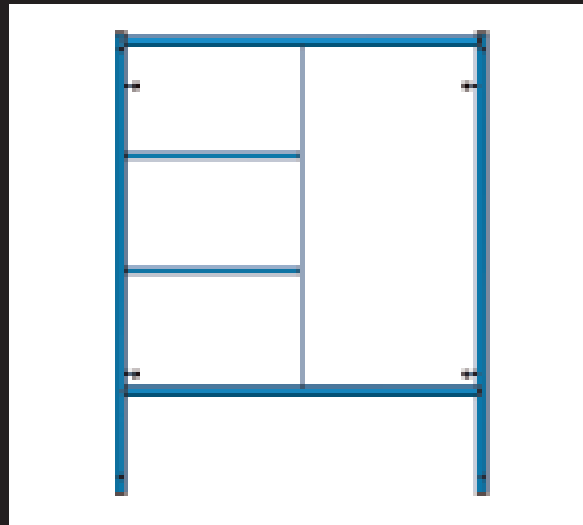

C-Size (Blue) Frames

World Headquarters: 6059 South Loop East | Houston, TX 77087

Offices In: California | Maryland | Hong Kong | China | United Kingdom | Latin America | Canada

713-673-7701 Phone | 800-720-6629 Toll Free | www.dss.net

[BACK TO TOP](#)

OPEN END FRAMES, C-SIZE (BLUE)

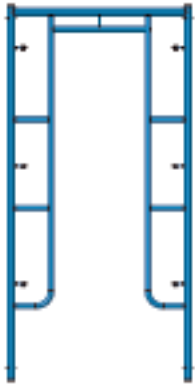

C-FO3W64H-V48L6
3'x6'4" Open End Frame
1.69", V-Lk 48" Spacing
41.3 lbs

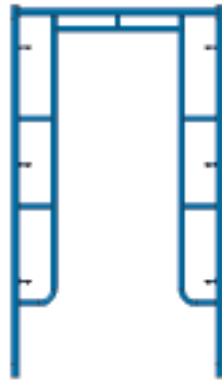

C-FO42W64H-V48L6
42"x6'4" Open End Frame
1.69", V-Lk 48" Spacing
42.3 lbs.

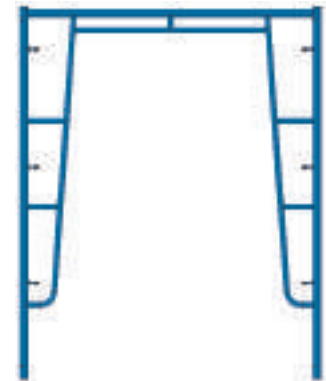

C-FO5W64H-V48L6
5'x6'4" Open End Frame
1.69", V-Lk 48" Spacing
44.8 lbs.

STEP FRAMES, C-SIZE (BLUE)

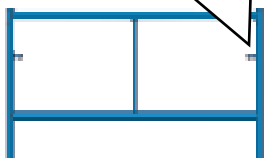

C-FS5W3H-V24L6
5'x3' Step Frame
1.69", V-Lk 24" Spacing
27.8 lbs.

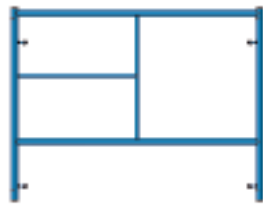

C-FS5W4H-V36L6
5'x3' Step Frame
1.69", V-Lk 24" Spacing
27.8 lbs.

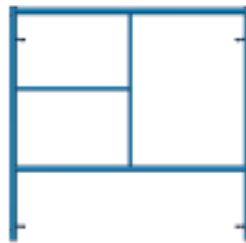

C-FS5W5H-V48L6
5'x5' Step Frame
1.69", V-Lk 48" Spacing
37.1 lbs.

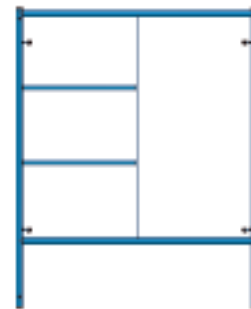

C-FS5W64H-V48L6
5'x6'4" Step Frame
1.69", VC-Lk 48" Spacing
44.4 lbs.



PN-CPC
9" C-size Coupling Pin
w/ 1" Collar
1.25 lbs.

C-Size Frame Information

- 1.69" (1-11/16") OD Leg Tube, 13 Gauge
- Uses PN-CPC Coupling Pin
- Standard Color Dark blue
- First lock 6" from top of frame leg
- V-Locks
- Spring Retainer hole drilled at 45 degrees

World Headquarters: 6059 South Loop East | Houston, TX 77087

Offices In: California | Maryland | Hong Kong | China | United Kingdom | Latin America | Canada



C-Size Accessories

World Headquarters: 6059 South Loop East | Houston, TX 77087

Offices In: California | Maryland | Hong Kong | China | United Kingdom | Latin America | Canada

713-673-7701 Phone | 800-720-6629 Toll Free | www.dss.net

C-SIZE BASE COMPONENTS



CAS8B
8" Caster
(B & C Frames)
12.3 lbs.

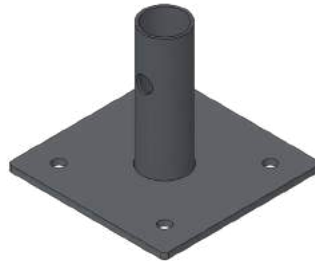

BPRBC
Rigid Base Plate
(B & C Frames)
1.9 lbs.



BPLJBC
24" Leveling Jack w/ base plate
(B & C Frames) Solid
12.3 lbs.



BPSJC
24" Swivel Jack w. Base Plate
(B & C Frames) Solid
11.6 lbs.



FS-UHJ68B
5" x 8" U-Head Jack
(B & C Frames)
15.6 lbs.



BPLEC
Leveling Extension w/ Socket
(B & C Frames) Solid
11.2 lbs.



C-OR
Frame Outrigger
(B&C Frames)
15.0 lbs.



FS-SB
Stair Tower Starter Bar
9.3 lbs.

TUBE CROSS BRACES

1"x2mm

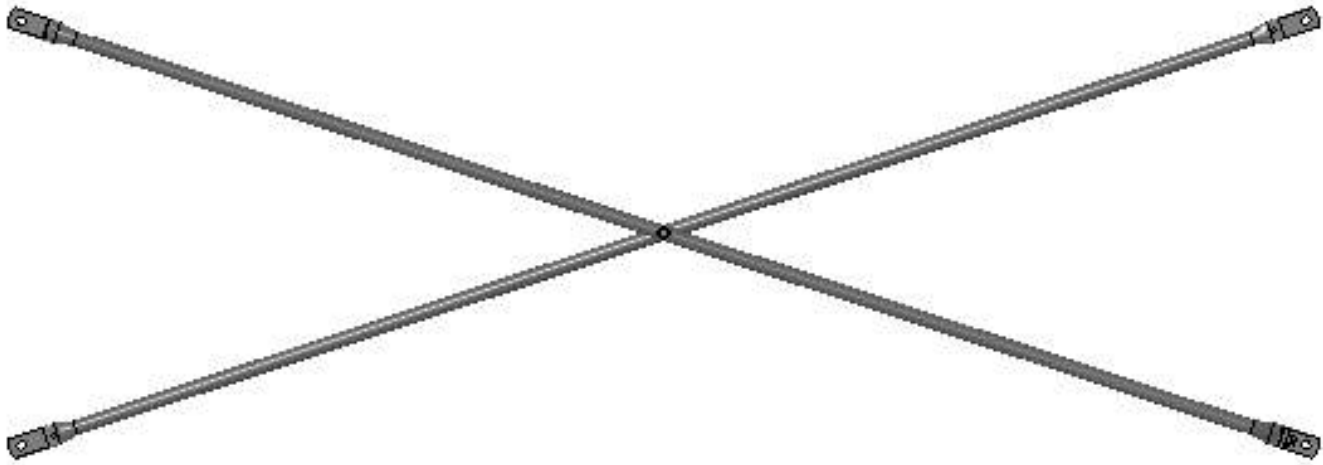

Lock Spacing	Bay Length					
	4'	5'	6'	7'	8'	10'
12"				BR0712H		BR01012H
24"	BR0424H	BR0524H	BR0624H	BR0724H	BR0824H	BR01024H
36"	BR043648H	BR053648H	BR063648H	BR0736H	BR083648H	BR01036H
				BR073648H		BR0103648H
48"	BR043648H	BR053648H	BR063648H	BR0748H	BR083648H	BR01048H
				BR073648H		BR0103648H

World Headquarters: 6059 South Loop East | Houston, TX 77087

Offices In: California | Maryland | Hong Kong | China | United Kingdom | Latin America | Canada

713-673-7701 Phone | 800-720-6629 Toll Free | www.dss.net

[BACK TO TOP](#)

LADDERS AND LADDER BRACKETS



LDRSAUBG
SAU Ladder Bracket
(Channel Style)
5.8 lbs.



LDB17W
17" Wide Ladder Bracket 7.25"
7.06lbs



LD17W6
17" Wide Ladder 6' High
20.06 lbs



LD17W3
17" Wide Ladder 3' High
10.58 lbs

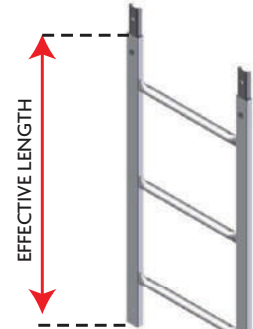

LDRSAU3G
3' SAU Ladder (Channel Style) - 10.2 lbs.

LDRSAU6G
6' SAU Ladder (Channel Style) - 18.9 lbs.

PINS

SIZES LISTED ABOVE ARE STOCK SIZES

*** Special, non-stock sizes available upon request ***



PN-SP2
2" Snap Pin
0.2 lbs.



PN-SR
Spring Retainer
0.1 lbs.



PN-HP3
3" Hinge Pin
0.2 lbs.



PN-PTPU
Universal Pig Tail Pin
0.25 lbs.



PN-SP4
4" Snap Pin
0.35 lbs.

World Headquarters: 6059 South Loop East | Houston, TX 77087

Offices In: California | Maryland | Hong Kong | China | United Kingdom | Latin America | Canada

SIDE BRACKETS FOR C-SIZE FRAMES



FS-SB12HC
12" Side Bracket
(Saddle Hanger)
8.2 lbs.



FS-SB20HC
20" Side Bracket
(Saddle Hanger)
10.1 lbs.



FS-SB30HC
30" Side Bracket
(Saddle Hanger)
11 lbs.



FS-SB20EC
20" End Bracket
(Saddle Hanger)
9.9 lbs.



FS-SB20AC
20" Side Bracket
(Angle Hanger)
9.5 lbs.

ACCESS FOR C-SIZE FRAMES

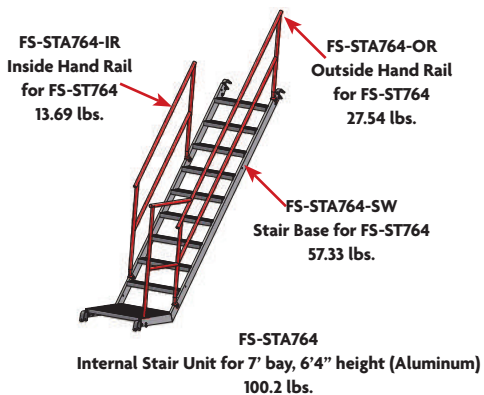

World Headquarters: 6059 South Loop East | Houston, TX 77087

Offices In: California | Maryland | Hong Kong | China | United Kingdom | Latin America | Canada

C-SIZE GUARDRAIL SYSTEMS

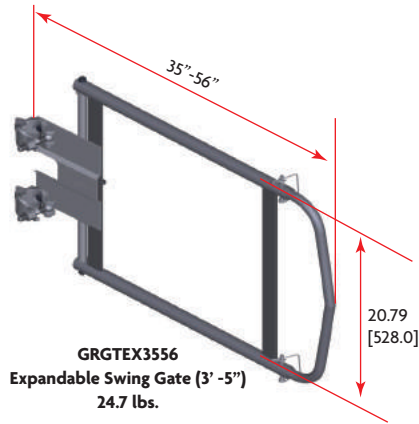

GR7ISP
7' Side Guard Rail Panel
17.7 lbs.

GR10ISP
10' Side Guard Rail Panel
21.0 lbs.

GR3BC
3' Tube Guard Rail
2.5 lbs.

GR42BC
42" Tube Guard Rail
3.0 lbs.

GR5BC
5' Tube Guard Rail
3.6 lbs.

GR7
7' Tube Guard Rail
5.3 lbs.

GR10
10' Tube Guard Rail
7.0 lbs.



GRSP7
7' EZ Side Guard Panel
15.0 lbs.

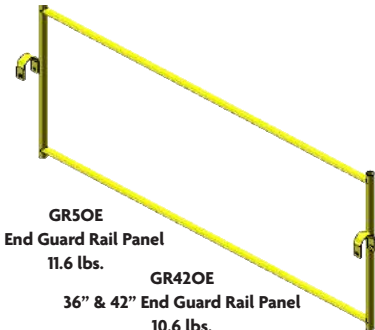

GR5OE
5' End Guard Rail Panel
11.6 lbs.

GR42OE
36" & 42" End Guard Rail Panel
10.6 lbs.

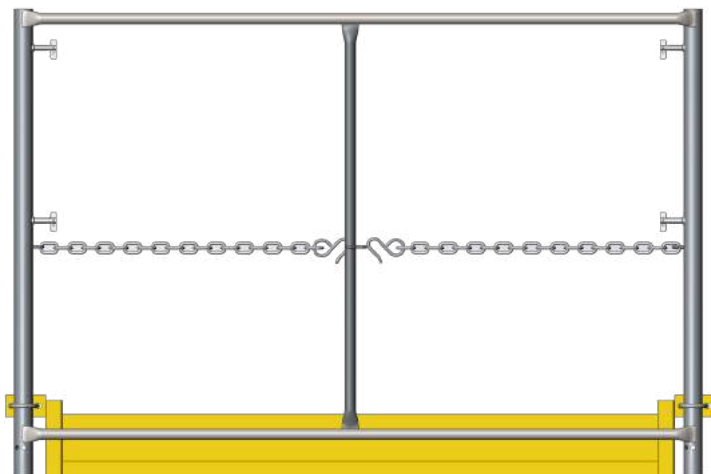

GRE5C
5' EZ End Panel (B & C Frames)
35.0 lbs.



GRPFC4D
Female Corner Guard Rail Post
(C-Frames)
7.4 lbs.

World Headquarters: 6059 South Loop East | Houston, TX 77087

Offices In: California | Maryland | Hong Kong | China | United Kingdom | Latin America | Canada

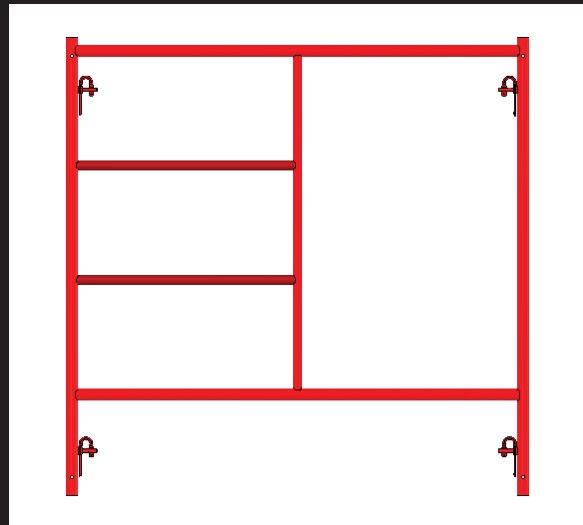

B-Size (Red) Frames

World Headquarters: 6059 South Loop East | Houston, TX 77087

Offices In: California | Maryland | Hong Kong | China | United Kingdom | Latin America | Canada

713-673-7701 Phone | 800-720-6629 Toll Free | www.dss.net

[BACK TO TOP](#)

OPEN END FRAMES, B-SIZE (RED)

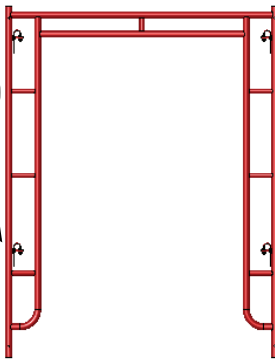
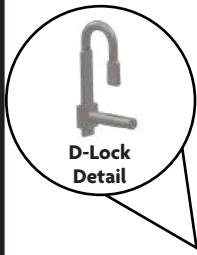

B-FO5W67H-D48
5'x6'7" Open End Frame
1.625", D-Lk 48" Spacing
49.2 lbs.

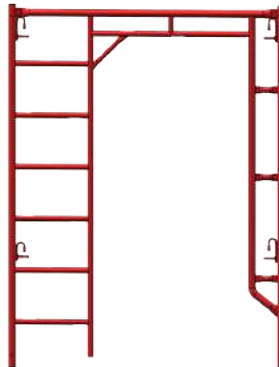

B-FOL5W67H-D48
5'x6'7" Open End Ladder Frame
1.625", D-Lk 48" Spacing
58.6 lbs.

B-Size Frame Information

- 1.625" (1-5/8") OD Leg Tube, 13 Gauge
- Uses PN-CPBNC, PN-CPB1/8 or PN-CPB Coupling Pin
- Standard Color Red
- First lock 7" from top of frame leg
- D-Locks
- Spring Retainer hole drilled at 90 degrees

STEP FRAMES, B-SIZE (RED)

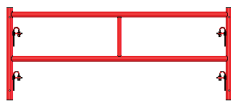

B-FS5W21H-D12
5'x2'1" Step Frame
1.625", D-Lk 12" Spacing
25.4 lbs.

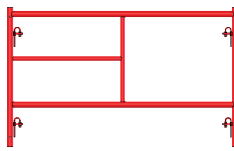

B-FS5W31H-D24
5'x3'1" Step Frame
1.625", D-Lk 24" Spacing
32.4 lbs.

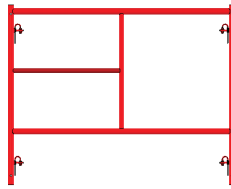

B-FS5W41H-D36
5'x4'1" Step Frame
1.625", D-Lk 36" Spacing
35.6 lbs.

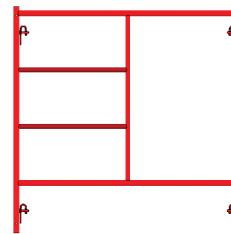

B-FS5W51H-D48
5'x5'1" Step Frame
1.625", D-Lk 48" Spacing
42.4 lbs.

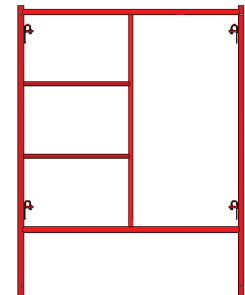

B-FS5W67H-D48
5'x6'7" Step Frame
1.625", D-Lk 48" Spacing
47.9 lbs.



7" B-size Coupling Pin
w/ No Collar
0.68 lbs.



7" B-size Coupling Pin
w/ 1/8" Collar
0.7 lbs.



9" B-size Coupling Pin
w/ 1" Collar
1.21 lbs.

World Headquarters: 6059 South Loop East | Houston, TX 77087

Offices In: California | Maryland | Hong Kong | China | United Kingdom | Latin America | Canada

NARROW LADDER FRAMES, B-SIZE (RED)

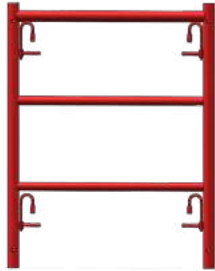

B-FL27W31H-D24
B-Size Ladder Frame
29" x 31", D-Lck
19.94 lbs.

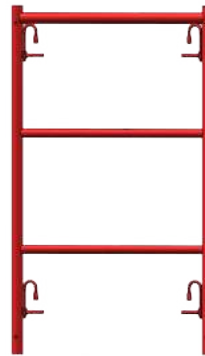

B-FL27W41H-D36
B-Size Ladder Frame
29" x 41", D-Lck
22 lbs.



B-FL27W51H-D48
B-Size Ladder Frame
29" x 51", D-Lck
27.23 lbs.



B-FL27W67H-D48
B-Size Ladder Frame
29" x 67", D-Lck
33.98 lbs.

World Headquarters: 6059 South Loop East | Houston, TX 77087

Offices In: California | Maryland | Hong Kong | China | United Kingdom | Latin America | Canada

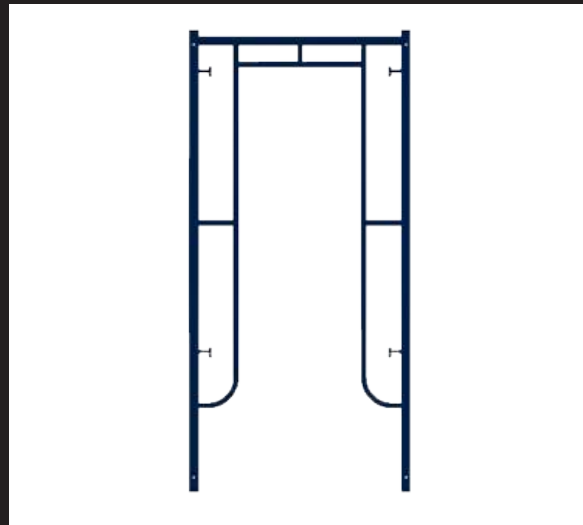

B-Size (Blue) Frames

World Headquarters: 6059 South Loop East | Houston, TX 77087

Offices In: California | Maryland | Hong Kong | China | United Kingdom | Latin America | Canada

OPEN END FRAMES, B-SIZE (BLUE)

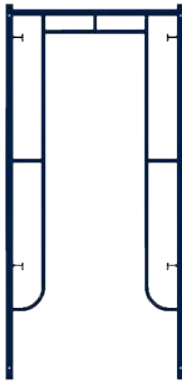
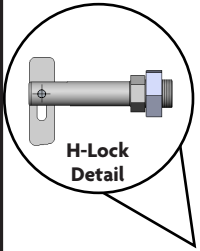

BFO3W67HH48
3'x6'7" Open End Frame
1.63" H-Lk
36.2 lbs.

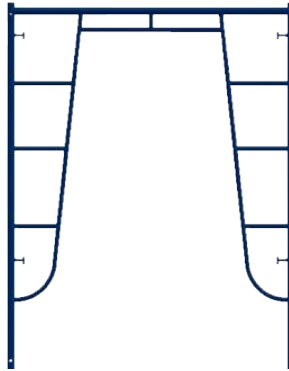

BFO5W67HH48
5'x6'7" Open End Frame
1.63" H-Lk 48"
43.2 lbs.

B-Size Frame Information

- 1.625" (1-5/8") OD Leg Tube, 13 Gauge
- Uses PN-CPBNC, PN-CPB1/8 or PN-CPB Coupling Pin
- Standard Color Blue
- First lock 7" from top of frame leg
- H-Locks
- Spring Retainer hole drilled at 90 degrees

STEP FRAMES, B-SIZE (BLUE)

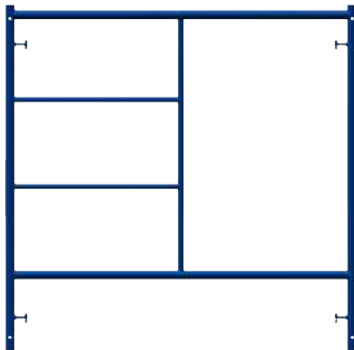

BFS5W51HH48
5'x5'1" Galvanized Step Frame
1.63" H-Lk
36.2 lbs.

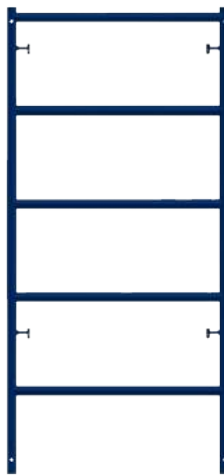

B-FS5W31H-D24
5'x3'1" Step Frame
1.63" H-Lk
43.4 lbs.



7" B-size Coupling Pin
w/ No Collar
0.68 lbs.



9" B-size Coupling Pin
w/ 1" Collar
1.21 lbs.



7" B-size Coupling Pin
w/ 1/8" Collar
0.7 lbs.

World Headquarters: 6059 South Loop East | Houston, TX 77087

Offices In: California | Maryland | Hong Kong | China | United Kingdom | Latin America | Canada

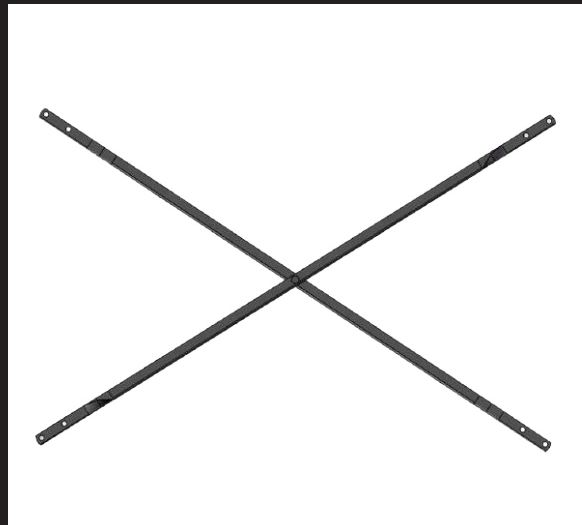

B-Size (Red) Accessories

World Headquarters: 6059 South Loop East | Houston, TX 77087

Offices In: California | Maryland | Hong Kong | China | United Kingdom | Latin America | Canada

713-673-7701 Phone | 800-720-6629 Toll Free | www.dss.net

[BACK TO TOP](#)

ANGLE IRON CROSS BRACES B-SIZE RED

1.25" x 1.25" x 0.125"

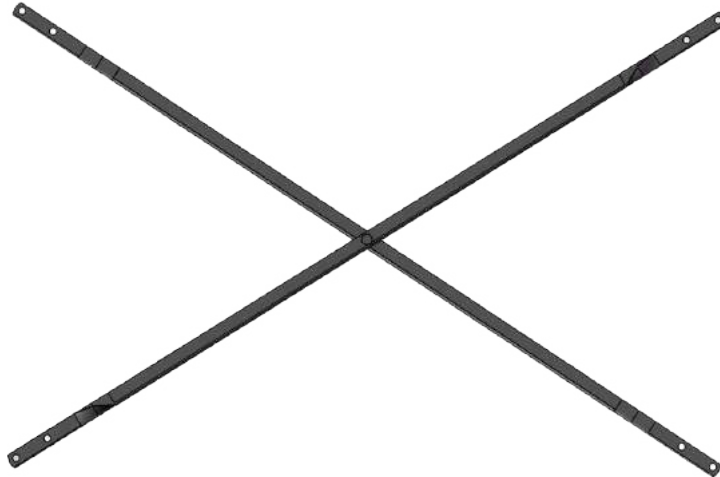

Lock Spacing	Bay Length					
	4'	5'	6'	7'	8'	10'
24"	BRA042436H	BRA052436H	BRA062436H	BRA072436H	BRA082436H	BRA102436H
36"	BRA042436H	BRA052436H	BRA062436H	BRA072436H	BRA082436H	BRA102436H
	BRA043648H	BRA053648H	BRA063648H	BRA073648H	BRA083648H	BRA103648H
48"	BRA043648H	BRA053648H	BRA063648H	BRA073648H	BRA083648H	BRA103648H

World Headquarters: 6059 South Loop East | Houston, TX 77087

Offices In: California | Maryland | Hong Kong | China | United Kingdom | Latin America | Canada

713-673-7701 Phone | 800-720-6629 Toll Free | www.dss.net

[BACK TO TOP](#)

B-SIZE RED ACCESSORIES



FSSB12HB
12" Wide Hanging Side Bracket
6.61 lbs

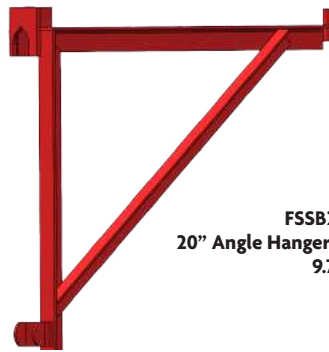

FSSB20ABPN
20" Angle Hanger Side Bracket w/ Pin
9.7 lbs.



FSSB2030
20"x30" Adjustable Side bracket
9.7 lbs.



FSSB20HB
20" WIDE HANGING SIDE
BRACKET: B-SIZE
11.86 lbs.



FSSB23HB
23" WIDE HANGING SIDE
BRACKET: B-SIZE
12.45 lbs.



BRS7HA
Straddle Brace 7' Lock Space 48"
19.47 lbs.

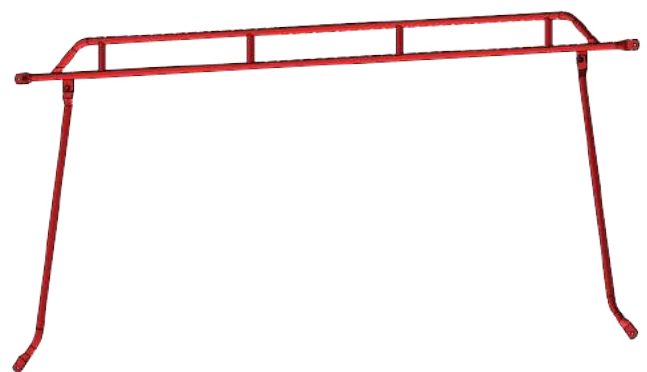

BRS10HA
Straddle Brace 10' Lock Space 48"
29.35 lbs.

World Headquarters: 6059 South Loop East | Houston, TX 77087

Offices In: California | Maryland | Hong Kong | China | United Kingdom | Latin America | Canada

B-SIZE RED ACCESSORIES

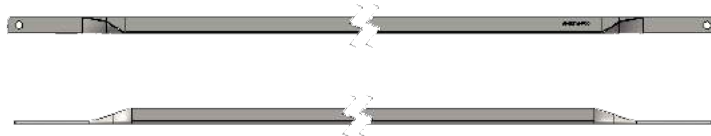
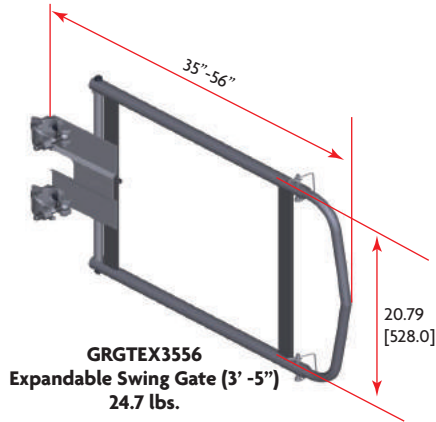

GRA7
7' Angle Iron Guard Rail

GRA5TBC
5' Angle Iron Guard Rail

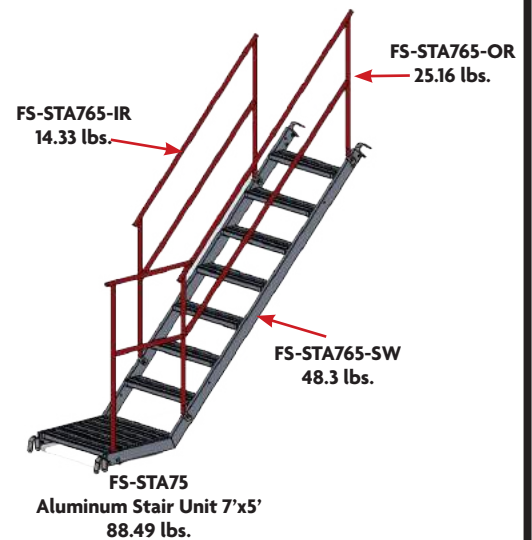
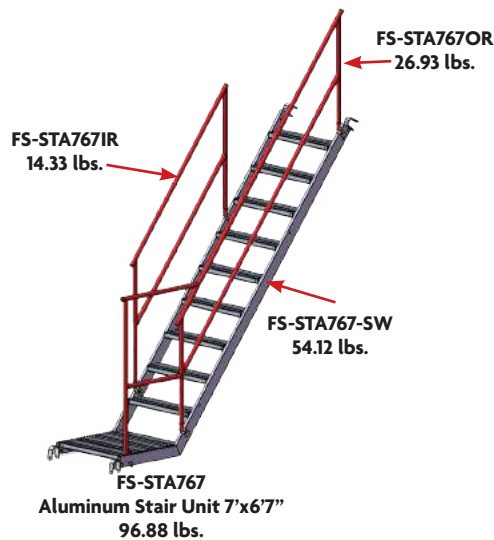
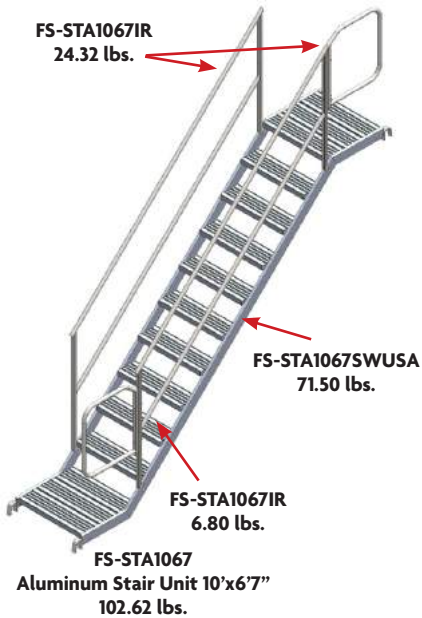

B-SIZE BASE COMPONENTS



CAS8B
8" Caster
(B & C Frames)
12.3 lbs.

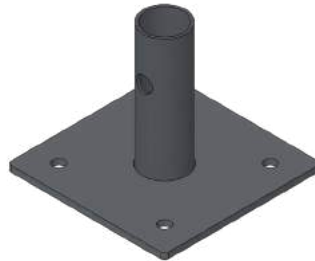

BPRBC
Rigid Base Plate
(B & C Frames)
1.9 lbs.



BPLJBC
24" Leveling Jack w/ base plate
(B & C Frames) Solid
12.3 lbs.



BPSJC
24" Swivel Jack w. Base Plate
(B & C Frames) Solid
11.6 lbs.



FS-UHJ68B
5" x 8" U-Head Jack
(B & C Frames)
15.6 lbs.



BPLEC
Leveling Extension w/ Socket
(B & C Frames) Solid
11.2 lbs.



C-OR
Frame Outrigger
(B&C Frames)
15.0 lbs.



FS-SB
Stair Tower Starter Bar
9.3 lbs.

B-SIZE GUARDRAIL SYSTEMS

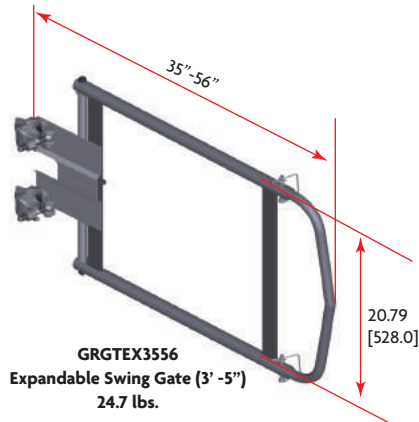

GR7ISP
7' Side Guard Rail Panel
17.7 lbs.

GR10ISP
10' Side Guard Rail Panel
21.0 lbs.

GR3BC
3' Tube Guard Rail
2.5 lbs.

GR42BC
42" Tube Guard Rail
3.0 lbs.

GR5BC
5' Tube Guard Rail
3.6 lbs.

GR7
7' Tube Guard Rail
5.3 lbs.

GR10
10' Tube Guard Rail
7.0 lbs.



GRSP7
7' EZ Side Guard Panel
15.0 lbs.

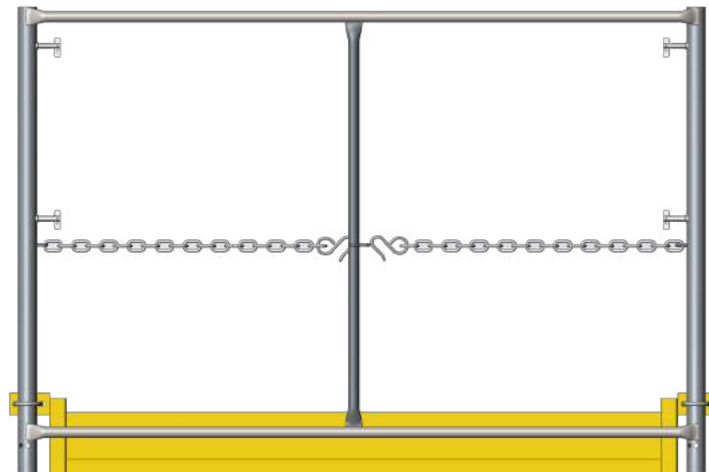

GRE5C
5' EZ End Panel (B & C Frames)
35.0 lbs.

World Headquarters: 6059 South Loop East | Houston, TX 77087

Offices In: California | Maryland | Hong Kong | China | United Kingdom | Latin America | Canada

713-673-7701 Phone | 800-720-6629 Toll Free | www.dss.net

[BACK TO TOP](#)

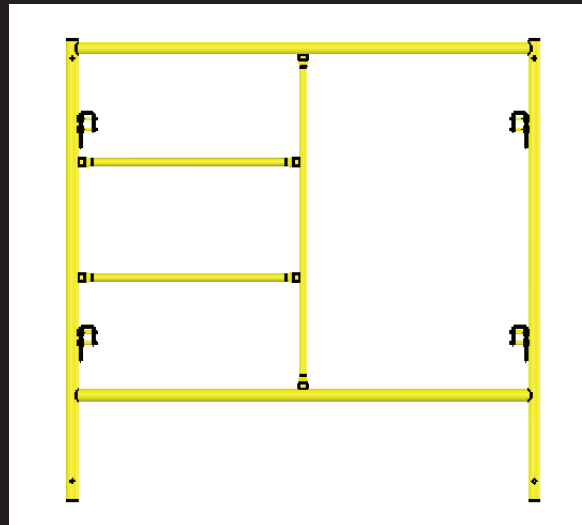

B-Size (Yellow) Frames

World Headquarters: 6059 South Loop East | Houston, TX 77087

Offices In: California | Maryland | Hong Kong | China | United Kingdom | Latin America | Canada

OPEN END FRAMES, B-SIZE (YELLOW)

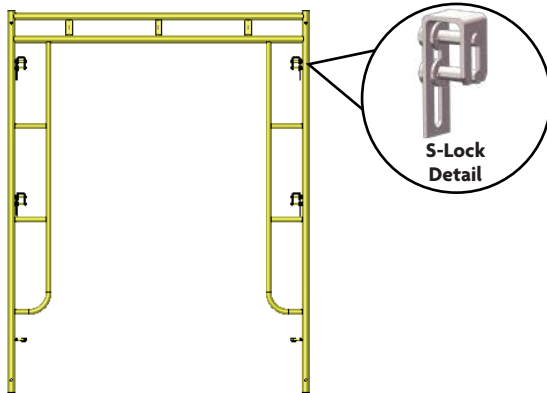

B-Size Frame Information

- 1.625" (1-5/8") OD Leg Tube, 13 Gauge
- Uses PN-CPB Coupling Pin
- Standard Color Yellow
- First lock 10.25" From top of frame leg on 5' and 6'6" tall frames
- First lock 6" from top of frame leg on 3' tall frames
- S-locks
- Spring Retainer hole drilled at 90 degrees
- 27-3/4" Lock Spacing

B-FO5W66H-S27
5'x6'6" Open End Frame
1.625"; S-Lk 27 3/4" Spacing
47.2 lbs.

STEP FRAMES, B-SIZE (YELLOW)

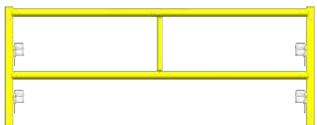

B-FS5W2H-S10L9
5'x2' Step Frame

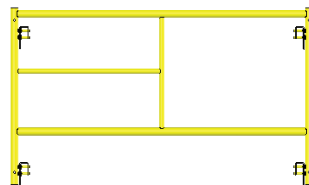

B-FS5W3H-S27
5'x3' Step Frame
1.625"; S-Lk 27-3/4" Lk Spacing
25.2 lbs.

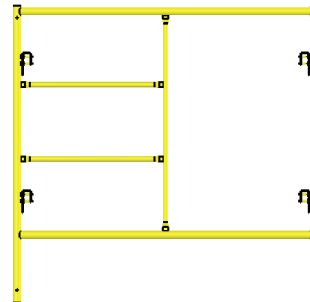

B-FS5W5H-S27
5'x5' Step Frame
1.625"; S-Lk 27-3/4" Lk Spacing
35.3 lbs.

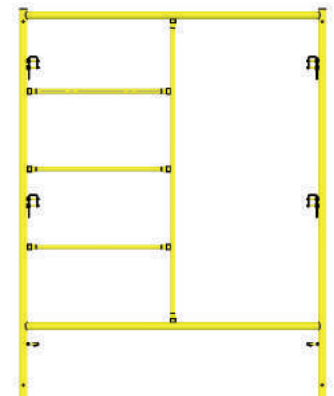

B-FS5W66H-S27
5'x6'6" Step Frame
1.625"; S-Lk 27-3/4" Lk Spacing
42.6 lbs.



PN-CPB
9" B-size Coupling Pin w/ 1" Collar
1.21 lbs.

World Headquarters: 6059 South Loop East | Houston, TX 77087

Offices In: California | Maryland | Hong Kong | China | United Kingdom | Latin America | Canada

LADDER FRAMES, B-SIZE (YELLOW)



B-FL4W3HS27L6
4'x3' Ladder Frame
30.5 lbs.

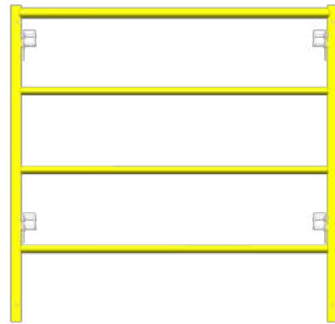

B-FL4W4HS27L6
4'x4' Ladder Frame
39.7 lbs.

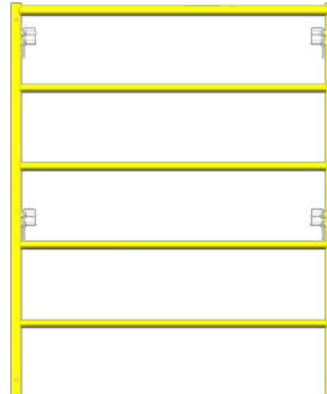

B-FL4W5HS27L6
4'x5' Ladder Frame
48.7 lbs.

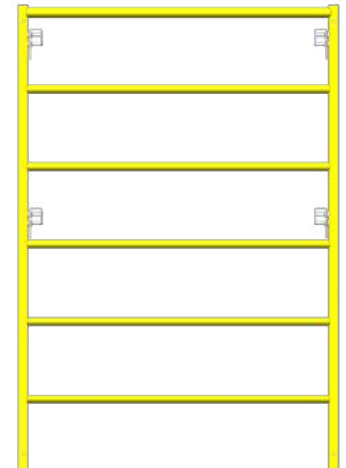

B-FL4W6HS27L6
4'x6' Ladder Frame
58.2 lbs.

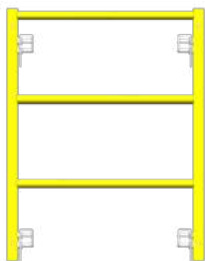

B-FL28W3HS27L6
28''x3' Ladder Frame
20.1 lbs.

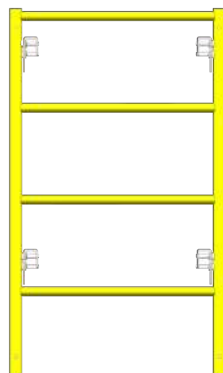

B-FL28W4HS27L6
28''x4' Ladder Frame
25.2 lbs.

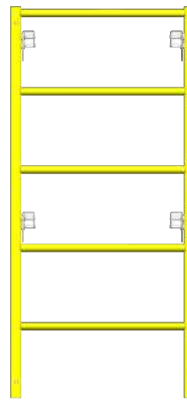

B-FL28W5HS27L6
28''x5' Ladder Frame
30.5 lbs.

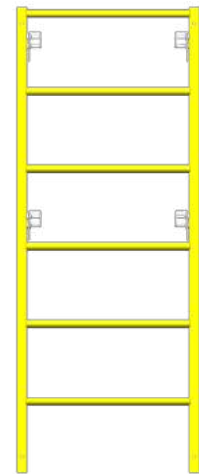

B-FL28W6HS27L6
28''x6' Ladder Frame
35.2 lbs.

World Headquarters: 6059 South Loop East | Houston, TX 77087

Offices In: California | Maryland | Hong Kong | China | United Kingdom | Latin America | Canada

LADDER FRAMES, B-SIZE (YELLOW)

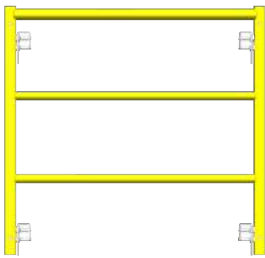

B-FL3W3HS27L6
3'x3' Ladder Frame
23.1 lbs.

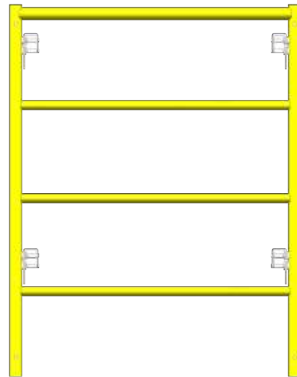

B-FL3W4HS27L6
3'x4' Ladder Frame
28.0 lbs.

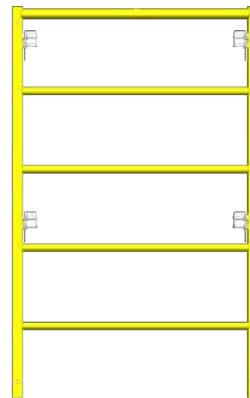

B-FL3W5HS27L6
3'x5' Ladder Frame
35.0 lbs.

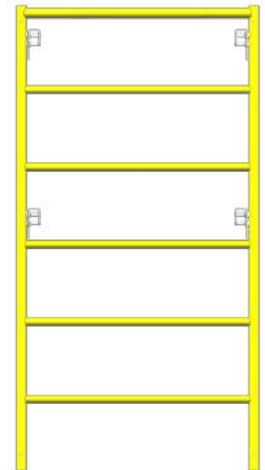

B-FL3W6HS27L6
3'x6' Ladder Frame
41.0 lbs.

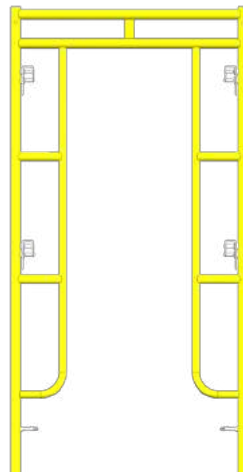

B-FO3W66HS27L6
3'x6'6" Ladder Frame
43.0 lbs.



B-Size (Yellow) Accessories

World Headquarters: 6059 South Loop East | Houston, TX 77087

Offices In: California | Maryland | Hong Kong | China | United Kingdom | Latin America | Canada

B-SIZE BASE COMPONENTS



CAS8B
8" Caster
(B & C Frames)
12.3 lbs.

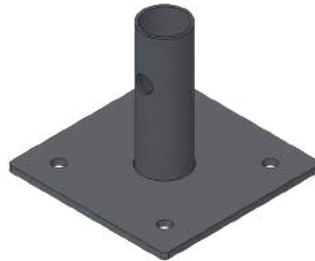

BPRBC
Rigid Base Plate
(B & C Frames)
1.9 lbs.



BPLJBC
24" Leveling Jack w/ base plate
(B & C Frames) Solid
12.3 lbs.



BPSJC
24" Swivel Jack w. Base Plate
(B & C Frames) Solid
11.6 lbs.



FS-UHJ68B
5" x 8" U-Head Jack
(B & C Frames)
15.6 lbs.



BPLEC
Leveling Extension w/ Socket
(B & C Frames) Solid
11.2 lbs.



C-OR
Frame Outrigger
(B&C Frames)
15.0 lbs.



FS-SB
Stair Tower Starter Bar
9.3 lbs.

TUBE CROSS BRACES

1"x2mm

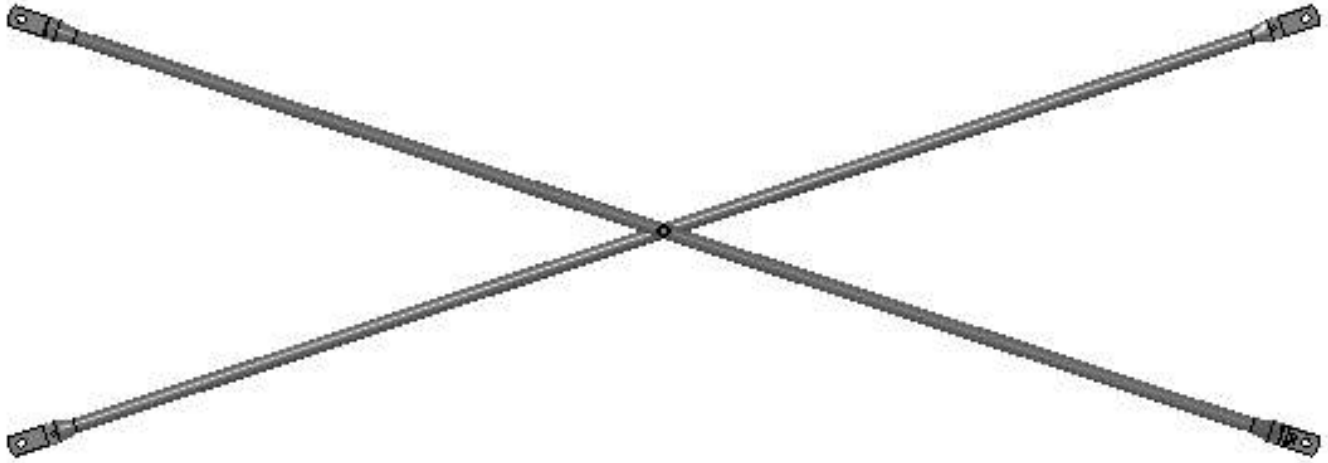

Lock Spacing	Bay Length		
	5'	7'	10'
27"	BR0527H	BR0727H	BR01027H

World Headquarters: 6059 South Loop East | Houston, TX 77087

Offices In: California | Maryland | Hong Kong | China | United Kingdom | Latin America | Canada

713-673-7701 Phone | 800-720-6629 Toll Free | www.dss.net

[BACK TO TOP](#)

LADDERS AND LADDER BRACKETS

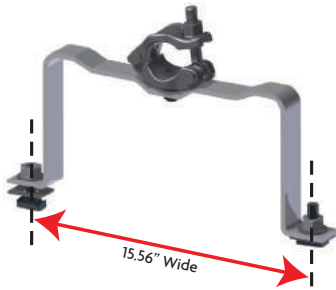

LDRSAUBG
SAU Ladder Bracket
(Channel Style)
5.8 lbs.



LDB17W
17" Wide Ladder Bracket 7.25"
7.06lbs



LD17W6
17" Wide Ladder 6' High
20.06 lbs



LD17W3
17" Wide Ladder 3' High
10.58 lbs

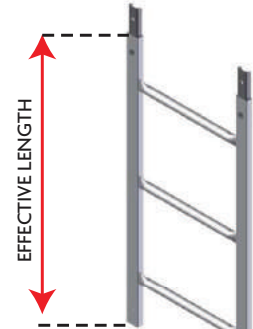

LDRSAU3G
3' SAU Ladder (Channel Style) - 10.2 lbs.

LDRSAU6G
6' SAU Ladder (Channel Style) - 18.9 lbs.

PINS

SIZES LISTED ABOVE ARE STOCK SIZES

*** Special, non-stock sizes available upon request ***



PN-SP2
2" Snap Pin
0.2 lbs.



PN-SR
Spring Retainer
0.1 lbs.



PN-HP3
3" Hinge Pin
0.2 lbs.



PN-PTPU
Universal Pig Tail Pin
0.25 lbs.



PN-SP4
4" Snap Pin
0.35 lbs.

World Headquarters: 6059 South Loop East | Houston, TX 77087

Offices In: California | Maryland | Hong Kong | China | United Kingdom | Latin America | Canada

SIDE BRACKETS FOR B-SIZE FRAMES



FS-SB12HC
12" Side Bracket
(Saddle Hanger)
8.2 lbs.



FS-SB20HC
20" Side Bracket
(Saddle Hanger)
10.1 lbs.



FS-SB30HC
30" Side Bracket
(Saddle Hanger)
11 lbs.



FS-SB20EC
20" End Bracket
(Saddle Hanger)
9.9 lbs.

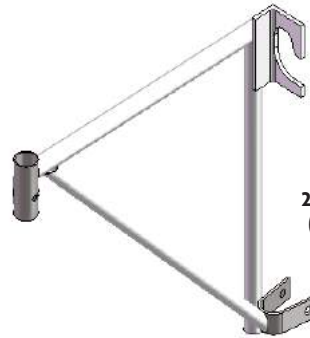

FS-SB20AC
20" Side Bracket
(Angle Hanger)
9.5 lbs.

ACCESS FOR B-SIZE FRAMES

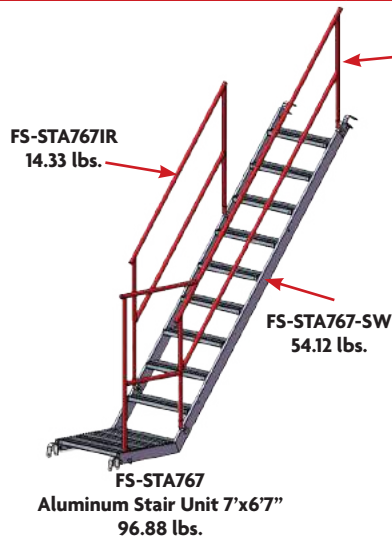

FS-STA767IR
14.33 lbs.

FS-STA767OR
26.93 lbs.

FS-STA767-SW
54.12 lbs.

FS-STA767
Aluminum Stair Unit 7'x6'7"
96.88 lbs.

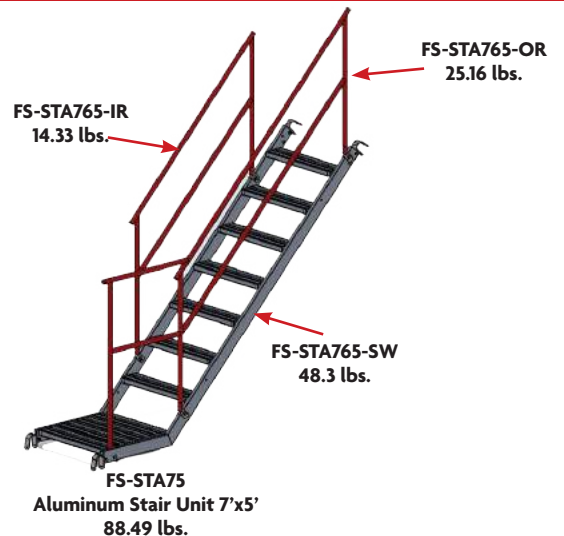

FS-STA765-IR
14.33 lbs.

FS-STA765-OR
25.16 lbs.

FS-STA765-SW
48.3 lbs.

FS-STA765
Aluminum Stair Unit 7'x5'
88.49 lbs.

World Headquarters: 6059 South Loop East | Houston, TX 77087

Offices In: California | Maryland | Hong Kong | China | United Kingdom | Latin America | Canada

B-SIZE GUARDRAIL SYSTEMS

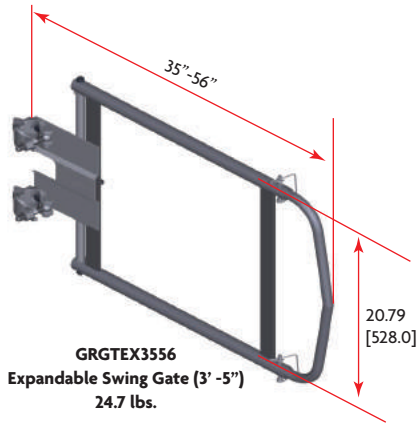

GR7ISP
7' Side Guard Rail Panel
17.7 lbs.

GR10ISP
10' Side Guard Rail Panel
21.0 lbs.

GR3BC
3' Tube Guard Rail
2.5 lbs.

GR42BC
42" Tube Guard Rail
3.0 lbs.

GR5BC
5' Tube Guard Rail
3.6 lbs.

GR7
7' Tube Guard Rail
5.3 lbs.

GR10
10' Tube Guard Rail
7.0 lbs.



GRSP7
7' EZ Side Guard Panel
15.0 lbs.

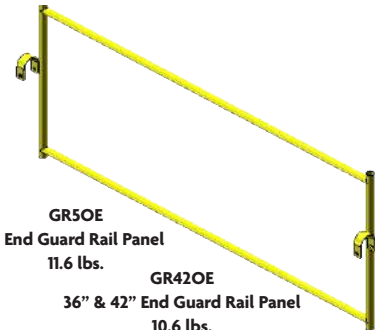

GR5OE
5' End Guard Rail Panel
11.6 lbs.

GR42OE
36" & 42" End Guard Rail Panel
10.6 lbs.

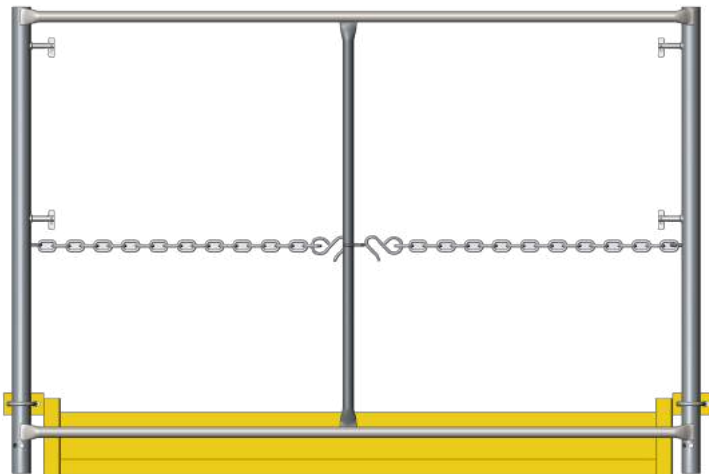

GRE5C
5' EZ End Panel (B & C Frames)
35.0 lbs.



GRPFB4D
Female Corner Guard Rail Post
(C-Frames)
7.4 lbs.

World Headquarters: 6059 South Loop East | Houston, TX 77087

Offices In: California | Maryland | Hong Kong | China | United Kingdom | Latin America | Canada

713-673-7701 Phone | 800-720-6629 Toll Free | www.dss.net

[BACK TO TOP](#)

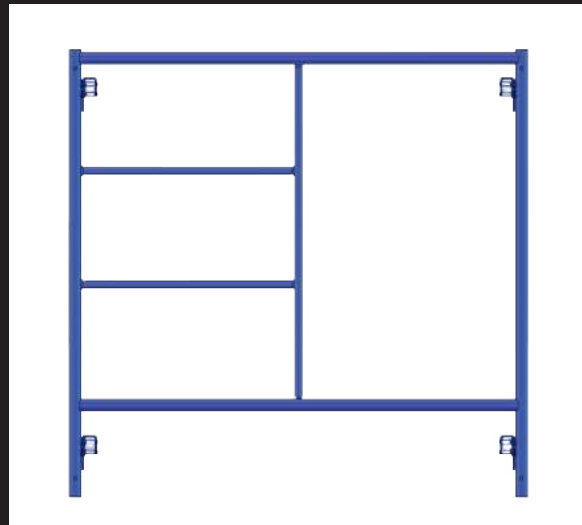
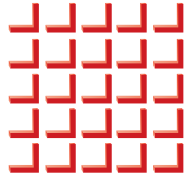

MISC. STOCK

Frames and Accessories

World Headquarters: 6059 South Loop East | Houston, TX 77087

Offices In: California | Maryland | Hong Kong | China | United Kingdom | Latin America | Canada

MISCELLANEOUS STOCK FRAMES

C-Size Frame Information

- 1.69" (1-11/16") OD Leg Tube, 13 Gauge
- Uses PN-CPC Coupling Pin
- First Lock 6" from top of frame leg
- S-Lock
- Spring Retainer hole drilled at 90 degrees
- 48" Lock Spacing
- Standard Color Blue



PN-CPC
9" C-size Coupling Pin
w/ 1" Collar
1.25 lbs.



S-Lock
Detail

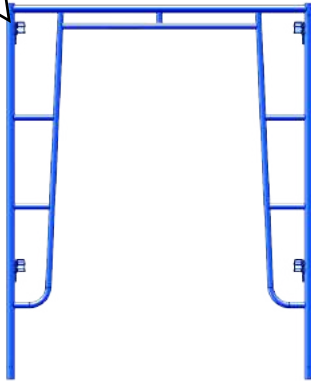

ABC-C-FO5645-L6
C-Size Open End Frame 5'x6'4"
47.63 lbs.

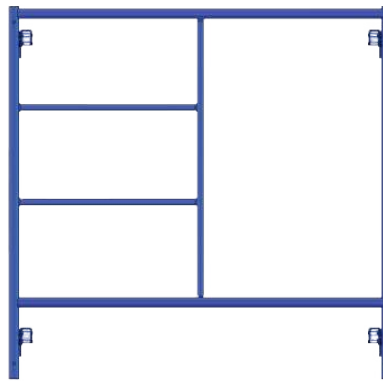

ABC-C-FS555
C-Size Step Frame 5'x5"
40.8 lbs.

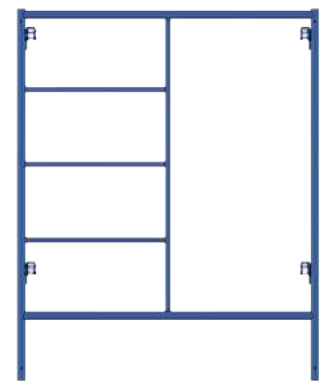

ABC-C-FS5645
C-Size Step Frame 5'x6'4"
44.3 lbs.

MISC. STOCK FRAME ACCESSORIES



ABC-C-GRPF4D
C-Size Guardrail Post
D-Locks
Holes at 90°
8.4 lbs.

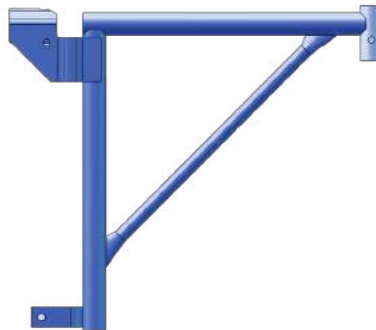

ABC-C-SB20H
C-Size 20" Side Bracket Saddle
Hanger
9.67 lbs.

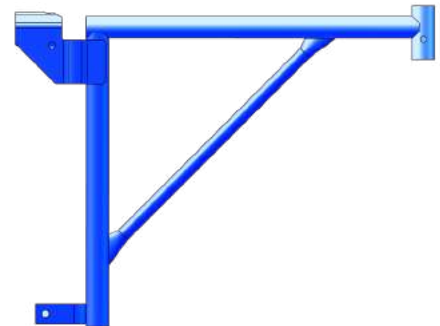

ABC-C-SB24H
C-Size 24" Side Bracket Saddle
Hanger
9.67 lbs.

World Headquarters: 6059 South Loop East | Houston, TX 77087

Offices In: California | Maryland | Hong Kong | China | United Kingdom | Latin America | Canada

MISCELLANEOUS STOCK FRAMES

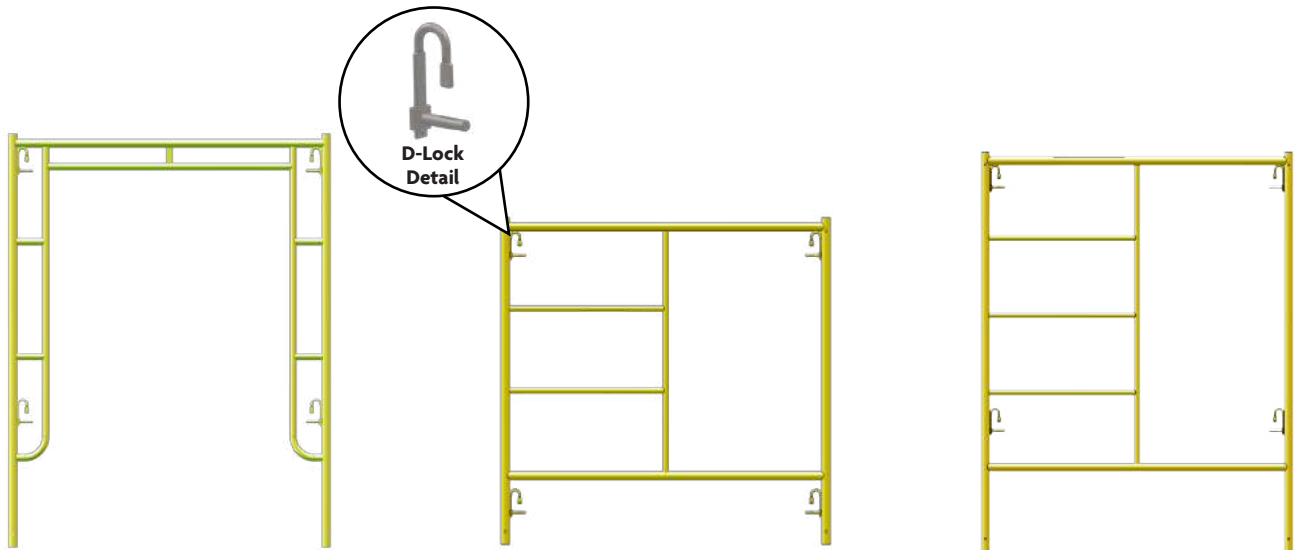

BKF0567D48
B-Size Open End Frame 5'x6'7"
45.75 lbs.

BKFS551D48
B-Size Step Frame 5'x5'1"
38.46 lbs.

BKFS567D48
B-Size Step Frame 5'x6'7"
48.27 lbs.

B-Size Frame Information

- 1.625" (1-5/8") OD Leg Tube, 13 Gauge
- Uses PN-CPBNC, PN-CPB1/8, or PN-CPB Coupling Pin
- First Lock 7" from top of frame leg
- D-Lock
- Spring Retainer hole drilled at 90 degrees
- 48" Lock Spacing
- Standard Color Yellow



PN-CPB
9" B-size Coupling Pin
w/ 1" Collar
1.21 lbs.

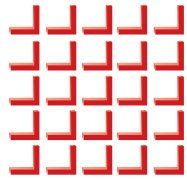

Canada

Frames and Accessories

World Headquarters: 6059 South Loop East | Houston, TX 77087

Offices In: California | Maryland | Hong Kong | China | United Kingdom | Latin America | Canada

713-673-7701 Phone | 800-720-6629 Toll Free | www.dss.net

[BACK TO TOP](#)

B-SIZE CANADA FRAMES

B-Size Frame Information

- 1.625" (1-5/8") OD Leg Tube, 13 Gauge
- Uses PN-CPB Coupling Pin
- L6 First Lock 6" from top of frame leg
- Spring Retainer hole drilled at 90 degrees
- L11/L10 First Lock 11.5"/10" from top of frame leg
- Standard Finish Galvanized



B-FL27W3HX27L6
27.5"Wx3'H Ladder Frame
X-Lk 27-3/4" Lk Spacing
21.2 lbs.

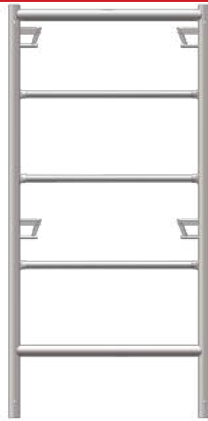

B-FL27W5HX27L6
27.5"Wx5'H Ladder Frame
X-Lk 27-3/4" Lk Spacing
21.2 lbs.

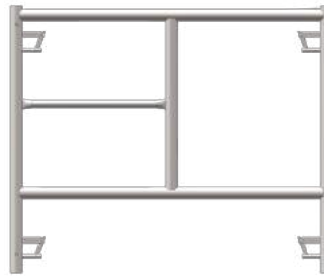

B-FS42W3HX27L6
42"Wx3'H Step Frame X-Lock
X-Lk 27-3/4" Lk Spacing
25.4 lbs.



B-FS5W5HX27L6
5'Wx5'H Step Frame X-Lock
X-Lk 27-3/4" Lk Spacing
25.4 lbs.



B-FO3W66HX27L11
3'Wx6'6"H Open Frame X-Lock X-Lk
27-3/4" Lk Spacing
48.4 lbs.



B-FO42W66HX27L11
42"Wx6'6"H Open Frame X-Lock X-Lk
27-3/4" Lk Spacing
50 lbs.

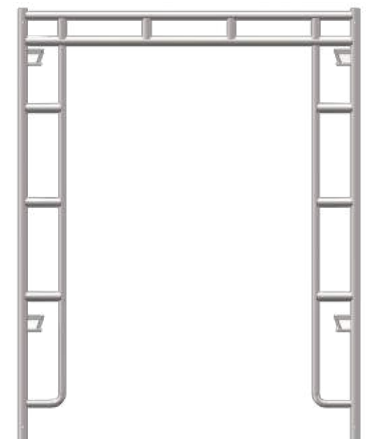

B-FO5W66HX27L11
5'Wx6'6"H Open Frame X-Lock
X-Lk 48" Lk Spacing
45.5 lbs.



PN-CPB
9" B-size Coupling Pin
w/ 1" Collar
1.21 lbs.

World Headquarters: 6059 South Loop East | Houston, TX 77087

Offices In: California | Maryland | Hong Kong | China | United Kingdom | Latin America | Canada

713-673-7701 Phone | 800-720-6629 Toll Free | www.dss.net

[BACK TO TOP](#)

C-SIZE CANADA FRAMES

C-Size Frame Information

- 1.69" (1-11/16") OD Leg Tube, 13 Gauge
- L6/L9 First Lock 6"/9" from top of frame leg
- Uses PN-CPC Coupling Pin
- Spring Retainer hole drilled at 90 degrees
- Standard Finish Galvanized



C-FO3W66HX48L6
36"Wx6'6"H Open Frame X-Lock
48" Lk Spacing
39.5lbs.

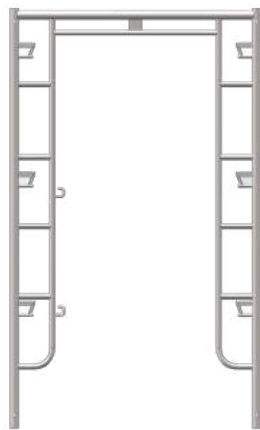

C-FO45W66HX48L6
45"Wx6'6"H Open Frame X-Lock
48" Lk Spacing
43.4lbs.

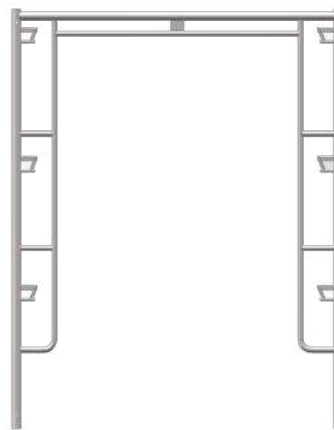

C-FO5W66HX48L6
5'Wx6'6"H Open Frame X-Lock
48" Lk Spacing
43.4lbs.



PN-CPC
9" C-size Coupling Pin
w/ 1" Collar
1.21 lbs.



**X-Lock
Detail**

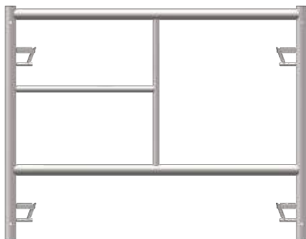

C-F55W3HX24L6
36"Wx3'H Step Frame X-Lock
24" Lk Spacing
39.5lbs.

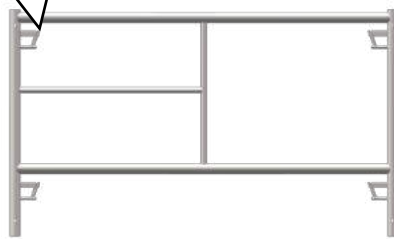

C-F545W3HX24L6
45"Wx3'H Step Frame X-Lock
24" Lk Spacing
43.4lbs.

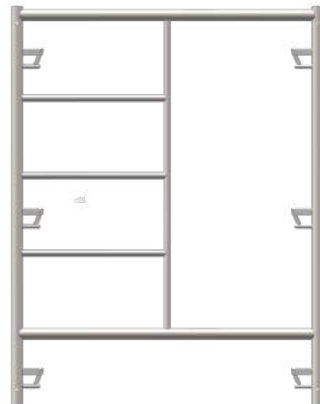

C-F545W3HX24L6
5'Wx5'H Step Frame X-Lock
48" Lk Spacing
44.3lbs.

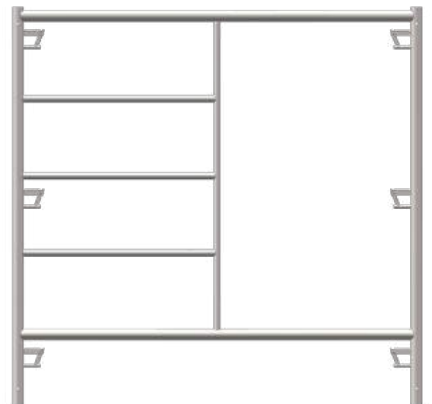

C-F5L5W5HX48L6
5'Wx5'H Ladder Step Frame X-Lock
48" Lk Spacing
42.6lbs.

World Headquarters: 6059 South Loop East | Houston, TX 77087

Offices In: California | Maryland | Hong Kong | China | United Kingdom | Latin America | Canada

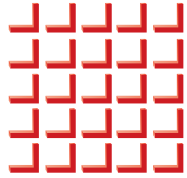

Utility Scaffolds

World Headquarters: 6059 South Loop East | Houston, TX 77087

Offices In: California | Maryland | Hong Kong | China | United Kingdom | Latin America | Canada

713-673-7701 Phone | 800-720-6629 Toll Free | www.dss.net

UTILITY SCAFFOLD



MPISU
6' Import Multi-Purpose Unit
145 lbs

Guard Rail Set and Outrigger also available

World Headquarters: 6059 South Loop East | Houston, TX 77087

Offices In: California | Maryland | Hong Kong | China | United Kingdom | Latin America | Canada

713-673-7701 Phone | 800-720-6629 Toll Free | www.dss.net

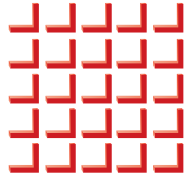

Planks, Decks and Boards

World Headquarters: 6059 South Loop East | Houston, TX 77087

Offices In: California | Maryland | Hong Kong | China | United Kingdom | Latin America | Canada

BOARDS AND DECKS



WBAA195
19" x 5' All Aluminum Scaffold Board - 22.0 lbs.

WBAA197
19" x 7' All Aluminum Scaffold Board - 28.0 lbs.

WBAA1910
19" x 10' All Aluminum Scaffold Board - 39.0 lbs.
Other Sizes Also Available

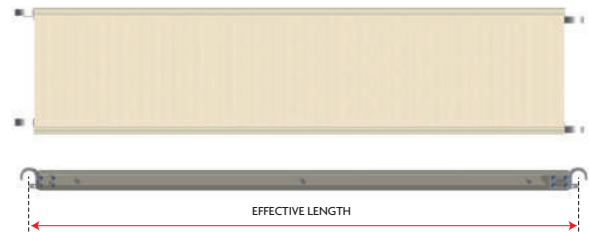

WBAP197H1
19" x 7' Alum/Plywood Scaffold Board - 32.2 lbs.

WBAP1910H1
19" x 10' Alum/Plywood Scaffold Board - 45.4 lbs.

WBAP287H2
28" x 7' Alum/Plywood Scaffold Board - 44.0 lbs.

WBAP2810H2
28" x 10' Alum/Plywood Scaffold Board - 54.0 lbs.

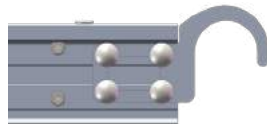

H1 Hook

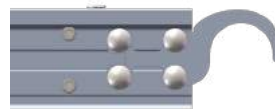

H2 Hook



WBAPSH287TH-H2
28" x 7' Alum/Plywood Hatch Plank
w/ Drop Down Ladder - 61.0 lbs.

WBAPSH288TH-H2
28" x 8' Alum/Plywood Hatch Plank
w/ Drop Down Ladder - 69.4 lbs.

WBAPSH2810TH-H2
28" x 10' Alum/Plywood Hatch Plank
w/ Drop Down Ladder - 86.0 lbs.



WBAASH287TH-H2
28" x 7' All Aluminum Hatch Plank
w/ Drop Down Ladder - 68.0 lbs.

WBAASH288TH-H2
28" x 8' All Aluminum Hatch Plank
w/ Drop Down Ladder - 84.9 lbs.

WBAASH2810TH-H2
28" x 10' All Aluminum Hatch Plank
w/ Drop Down Ladder - 100.3 lbs.

WOOD PLANK



WBWL0415E
4' Laminated Scaffold Board
15.2 lbs.

WBWL0615E
6' Laminated Scaffold Board
22.8 lbs.

WBWL0815E
8' Laminated Scaffold Board
30.4 lbs.

WBWL1015E
10' Laminated Scaffold Board
38.0 lbs.

WBWL1215E
12' Laminated Scaffold Board
45.6 lbs.

WBWL1615E
16' Laminated Scaffold Board
60.8 lbs.

WBW04
4' DI-65 Solid Sawn Scaffold Board
16.0 lbs.

WBW06
6' DI-65 Solid Sawn Scaffold Board
24.0 lbs.

WBW08
8' DI-65 Solid Sawn Scaffold Board
32.0 lbs.

WBW10
10' DI-65 Solid Sawn Scaffold Board
40.0 lbs.

WBW12
12' DI-65 Solid Sawn Scaffold Board
48.0 lbs.

WBW16
16' DI-65 Solid Sawn Scaffold Board
64.0 lbs.

World Headquarters: 6059 South Loop East | Houston, TX 77087

Offices In: California | Maryland | Hong Kong | China | United Kingdom | Latin America | Canada

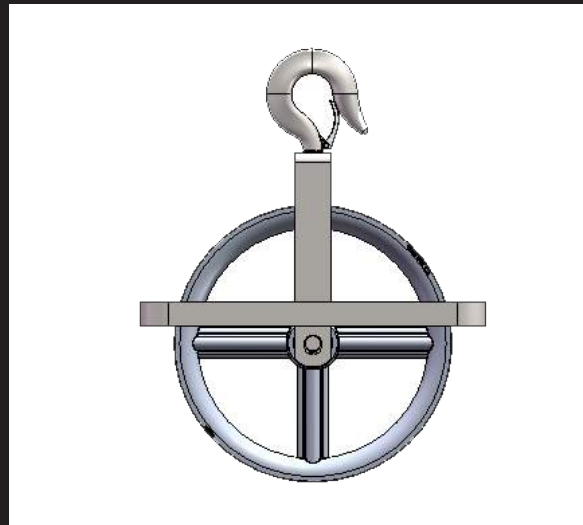

Universal Accessories

World Headquarters: 6059 South Loop East | Houston, TX 77087

Offices In: California | Maryland | Hong Kong | China | United Kingdom | Latin America | Canada

713-673-7701 Phone | 800-720-6629 Toll Free | www.dss.net

[BACK TO TOP](#)

UNIVERSAL ACCESSORIES

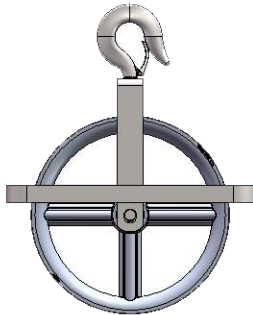

FSWW
Well Wheel
7.6 lbs.
Rated for 100 lbs.
Safety Factor 4:1



FSMBS2030
Mortar Board Stand 18"x20"x30"
32.5 lbs

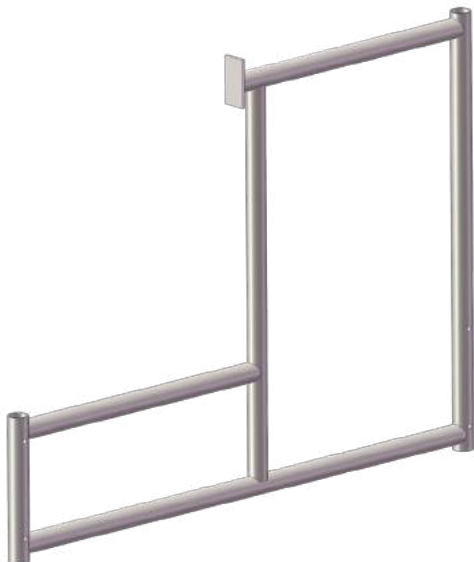

FSPFS
Pedestal Frame w/2-Legs
40 lbs



FSPFL
Pedestal Frame Leg
11 lbs

ADJUSTABLE U-HEAD JACK

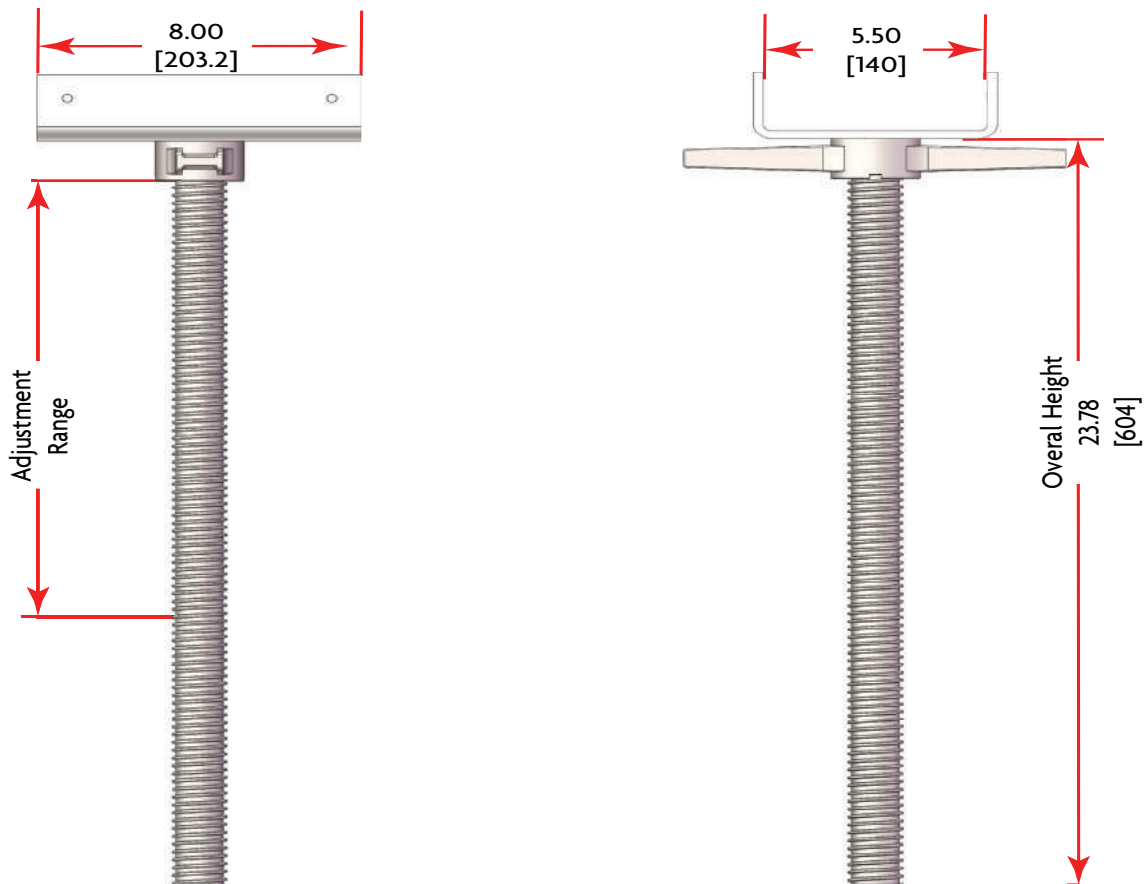

Product Code	Description	Adjustment Range		Weight	
		Inches	Meters	Lb	Kg
FSUHJ68B	6" x 8" U-Head Jack 1-3/8"	16.5	0.42	15.7	7.12

Threaded Tube O.D. 1 3/8"

World Headquarters: 6059 South Loop East | Houston, TX 77087

Offices In: California | Maryland | Hong Kong | China | United Kingdom | Latin America | Canada

713-673-7701 Phone | 800-720-6629 Toll Free | www.dss.net

[BACK TO TOP](#)

HEAVY DUTY BRACES

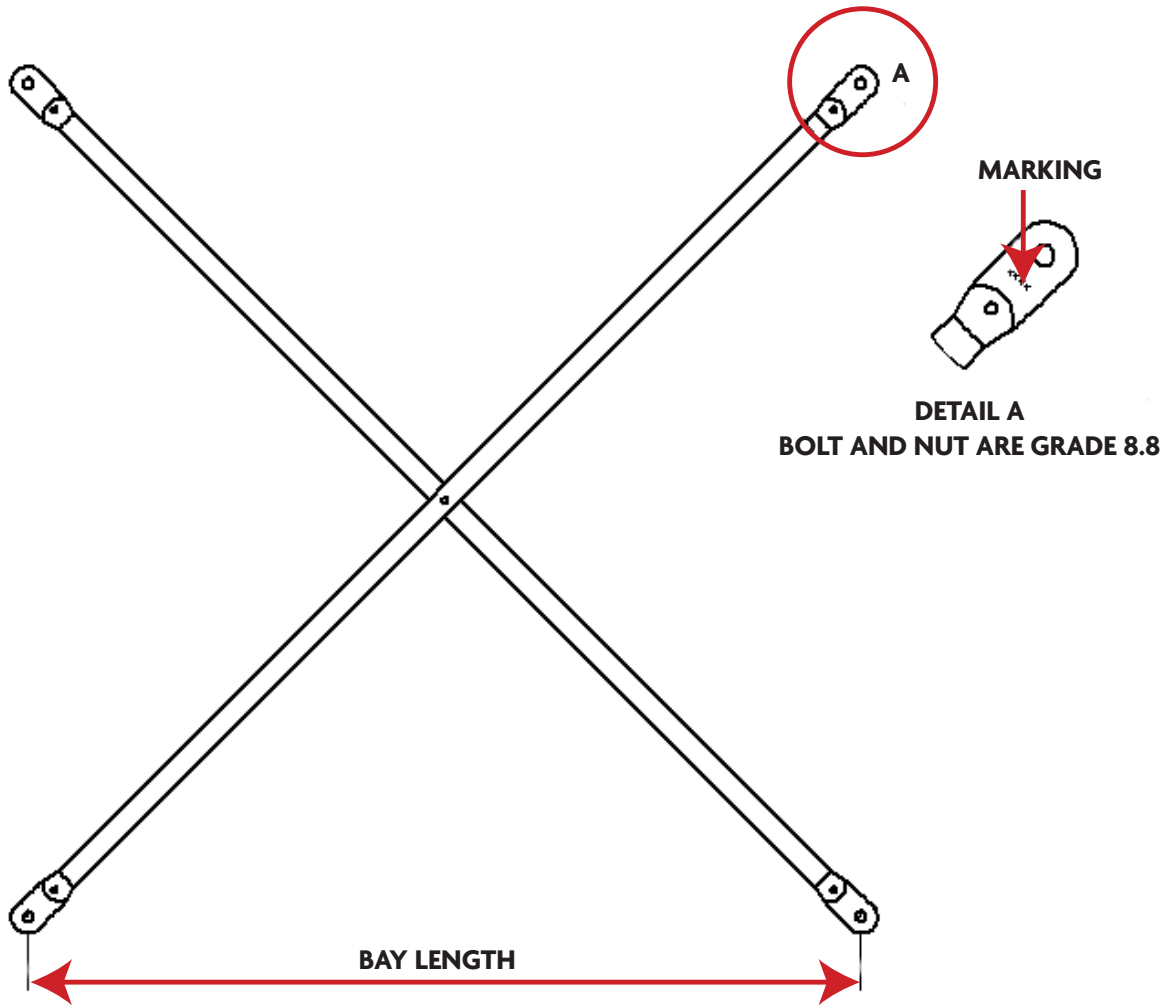

Product Code	Description	Bay Length		Lock Spacing	Marking
		in	mm	Inches	
BR0448D	4' Hole Brace	48	1219.2	48	0448HD
BR1248HD	12" Hole Brace	144	3657.6	48	1248HD

World Headquarters: 6059 South Loop East | Houston, TX 77087

Offices In: California | Maryland | Hong Kong | China | United Kingdom | Latin America | Canada

B & C LEVELING JACK BASE PLATE



BPLJBC
 24" Leveling Jack w/ base plate
 (B & C Frames) Solid
 12.3 lbs.

Product Code	Description	Load @ 18" Height (Kg-f)		Load @ 18" Height (lb-f)	
BPLJBC	24" Leveling Jack w/BP	16.5	0.42	15.7	7.12

(Safe Working Loads are based on a 4:1 Safety Factor.)

World Headquarters: 6059 South Loop East | Houston, TX 77087

Offices In: California | Maryland | Hong Kong | China | United Kingdom | Latin America | Canada

713-673-7701 Phone | 800-720-6629 Toll Free | www.dss.net

[BACK TO TOP](#)