

SHORING CATALOG



DSS 



TABLE OF CONTENTS

PRODUCTS & INFORMATION	PAGE
HL SHORING FRAMES (10k/leg).....	3
HL STEEL SHORING BASE JACKS	4
HL STEEL HEADS AND PLATES.....	5
HL STEEL SHORING PINS / CLIPS / LOCKS.....	6
SIDE BRACKET	6
ANGLE IRON CROSS BRACES.....	7
CLAMPS	8
TUBES	9
SHORING TOWER.....	10
SHORING JACK.....	11
SHORING FRAME ALLOWABLE WORKING LOADS	12
POST SHORES.....	13
MEDIUM DUTY POST SHORES.....	14
SLAB GUARDRAIL POST	15
ALUMINUM SHORING FRAMES.....	16
ALUMINUM SHORING ACCESSORIES	17
TUBE CROSS BRACES.....	18
ALUMINUM SHORING TOWER.....	19
ALUMINUM SHORING JACK.....	20
6.5"ALUMINUM STRINGER SHAB65xxxPN.....	21
6.5"ALUMINUM STRINGER SHAB65xxxBTF4PN	22
7.5"ALUMINUM STRINGER SHAB75xxxPN.....	23
7.25" DOUBLE FLANGE STRINGER SHAB725xxxPN.....	24

HL STEEL SHORING FRAMES (10K/LEG)

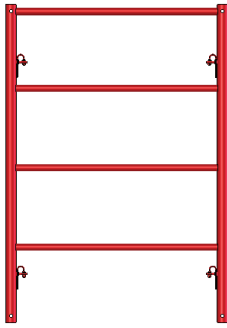

SHF4W6H-D48-P
4'x6' Shoring Frame
68.4 lbs

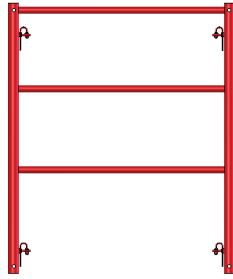

SHF4W5H-D48-P
4'x5' Shoring Frame
58.9 lbs



SHF4W4H-D36-P
4'x4' Shoring Frame
51.2 lbs



SHF4W3H-D24-P
4'x3' Shoring Frame
38.6 lbs

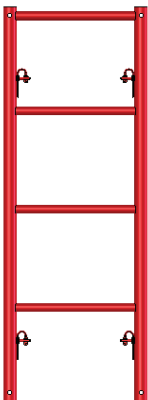

SHF2W6H-D48-P
2'x6' Shoring Frame
57.4 lbs

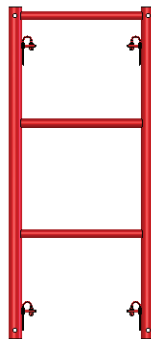

SHF2W5H-D48-P
2'x5' Shoring Frame
48.5 lbs

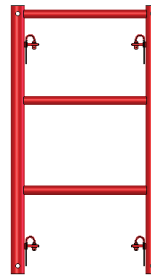

SHF2W4H-D36-P
2'x4' Shoring Frame
41.3 lbs

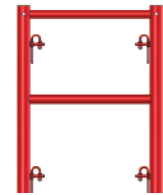

SHF2W3H-D24-P
2'x3' Shoring Frame
29.1 lbs

Steel Shoring Frame Information

- 2.375" (60.3mm) OD Leg Tube, 0.156" (4mm) Wall Thickness
- Uses SHPNCP-E Coupling Pin
- Standard Color Red
- First lock 13" from top of frame leg (6' tall frames)
- First lock 7" from top of leg (5', 4', and 3' tall frames)
- D-Lock

World Headquarters: 6059 South Loop East | Houston, TX 77087

Offices In: California | Maryland | Hong Kong | China | United Kingdom | Latin America | Canada

HL STEEL SHORING BASE JACKS



SHBPPJ
Shoring Screw Jack
13.45 Lbs



SHBPUJ
U-Head Screw Jack
18.52 Lbs



SHBPPJ-36
36" Hi-load Shoring Jack (1.9" x 36")
11.1 lbs

World Headquarters: 6059 South Loop East | Houston, TX 77087

Offices In: California | Maryland | Hong Kong | China | United Kingdom | Latin America | Canada

HL STEEL HEADS AND PLATES

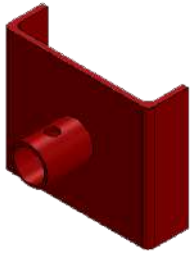

SHBPUH89
8"x9" Shoring U-Head (for Screw)
12.6 lbs

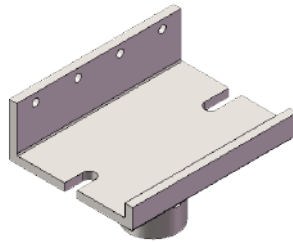

SHBPJH86
8"x5" Shoring J-Head (for Screw)
8.9 lbs

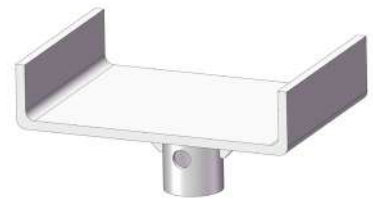

SHBPUH810
8" x 10" U Head (for Screw)
14.72 lbs.



SHUHTW88
8" X 8" U-Head (for Screw)
6.81 Lbs

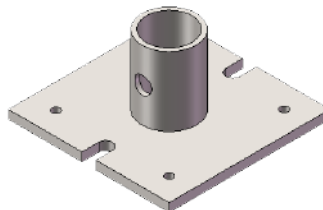

SHBPFH77
7"x7" Shoring Base Plate (for Screw)
6.0 lbs

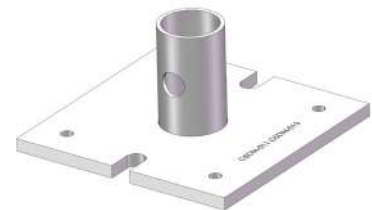

SHBP7
7" x 7" Shoring Base Plate (for Frame)
5.62 lbs.

HL STEEL SHORING PINS / CLIPS / LOCKS



SHPNJP4
Shoring 4" J Pin
.42 lbs

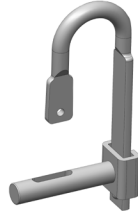

LKD
D-Lock 2 Piece Stud & Cane
.3 lbs



SHPNH
Hair Pin Cotter
.044 lbs



SHPNR
Drilling Rivet 3" x 5/8"
.35 lbs

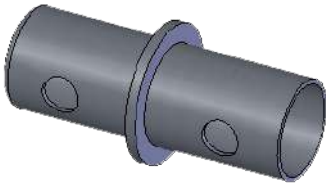

SHPNCPEP
Shoring Coupling Pin
1.54 lbs



SHPCIBN
Plastic Center Insert w/ Bolt & Nut
2.5 lbs.

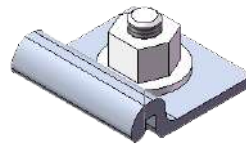

SHAB-CMPA
Aluminum Beam A-Clip
0.35 lbs



SHPSNP60
Post Shore Nail Plate - 60mm Tube
1.15 lbs

SIDE BRACKET



SHSB23H
23" Wide Hanging Side Bracket
12.55 Lbs

World Headquarters: 6059 South Loop East | Houston, TX 77087

Offices In: California | Maryland | Hong Kong | China | United Kingdom | Latin America | Canada

ANGLE IRON CROSS BRACES

1.25" x 1.25" x 0.125"

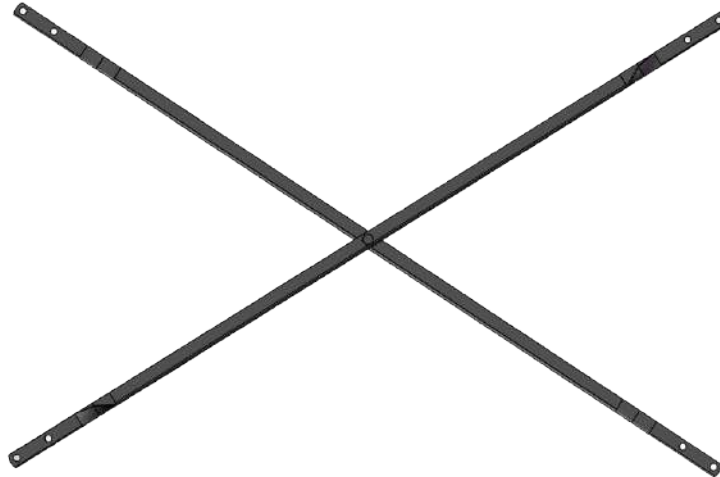

Lock Spacing	Bay Length					
	4'	5'	6'	7'	8'	10'
24"	BRA042436HD	BRA052436HD	BRA062436HD	BRA072436HD	BRA082436HD	BRA102436HD
36"	BRA042436HD	BRA052436HD	BRA062436HD	BRA072436HD	BRA082436HD	BRA102436HD
	BRA043648HD	BRA053648HD	BRA063648HD	BRA073648HD	BRA083648HD	BRA103648HD
48"	BRA043648HD	BRA053648HD	BRA063648HD	BRA073648HD	BRA083648HD	BRA103648HD

World Headquarters: 6059 South Loop East | Houston, TX 77087

Offices In: California | Maryland | Hong Kong | China | United Kingdom | Latin America | Canada

CLAMPS



CMPTS2X238
T Bolt Swivel Clamp
1.9" to 2.375"



CMPTR2X238
T Bolt Right Angle Clamp
1.9" to 2.375"



CMPTR2X35
T Bolt Right Angle Clamp
1.9" to 3.5"



CMPTSW2X35
T Bolt Swivel Clamp
1.9" to 3.5"

TUBES

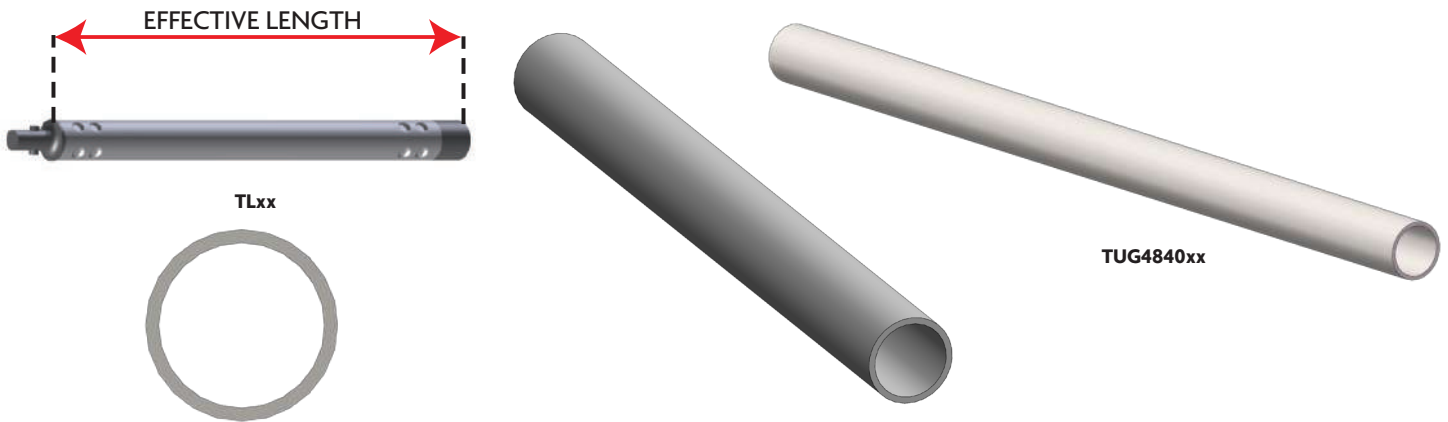

Product Code	Description	Effective Length		Weight	
		Inches	Meters	Lb	Kg
TL4	4' Twist Lock Tube	48	1.22	9.6	4.3
TL6	6' Twist Lock Tube	72	1.83	14.1	6.4
TL8	8' Twist Lock Tube	96	2.44	18.9	8.6
TL10	10' Twist Lock Tube	120	3.05	23.8	10.8
TL13	13' Twist Lock Tube	156	3.96	30.9	14.0
TL16	16' Twist Lock Tube	192	4.88	37.9	17.2

Product Code	Description	Length		Weight	
		Feet	Meters	Lb	Kg
TUG484004	4' x 1.9" OD Plain End Steel Tube	4	1.22	11.7	5.3
TUG484006	6' x 1.9" OD Plain End Steel Tube	6	1.83	17.4	7.9
TUG484008	8' x 1.9" OD Plain End Steel Tube	8	2.44	23.4	10.6
TUG484010	10' x 1.9" OD Plain End Steel Tube	10	3.05	29.1	13.2
TUG484013	13' x 1.9" OD Plain End Steel Tube	13	3.96	37.9	17.2
TUA484016	16' x 1.9" OD Plain End Steel Tube	16	4.88	46.7	21.2

World Headquarters: 6059 South Loop East | Houston, TX 77087

Offices In: California | Maryland | Hong Kong | China | United Kingdom | Latin America | Canada

SHORING TOWER

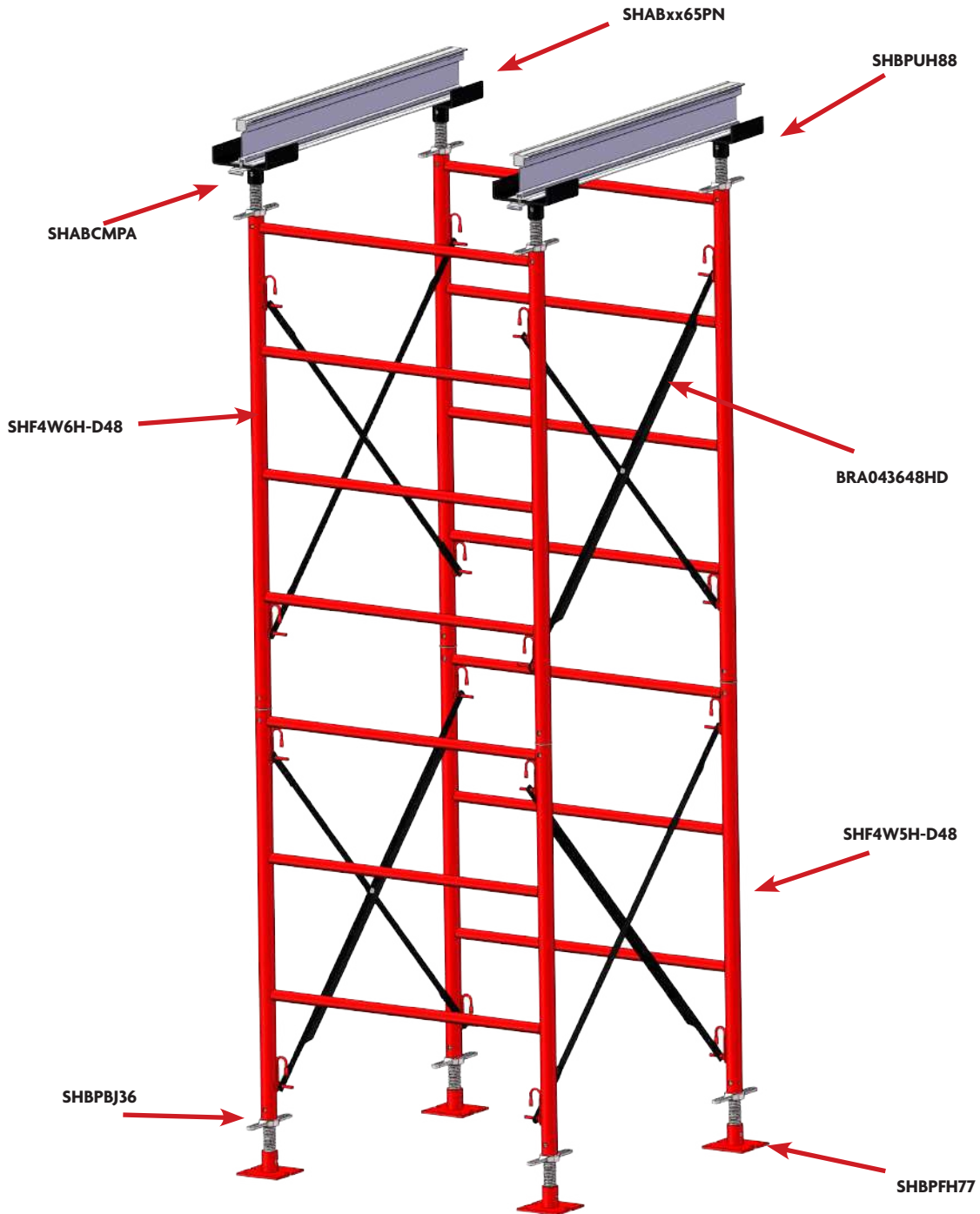

World Headquarters: 6059 South Loop East | Houston, TX 77087

Offices In: California | Maryland | Hong Kong | China | United Kingdom | Latin America | Canada

713-673-7701 Phone | 800-720-6629 Toll Free | www.dss.net

SHORING JACK

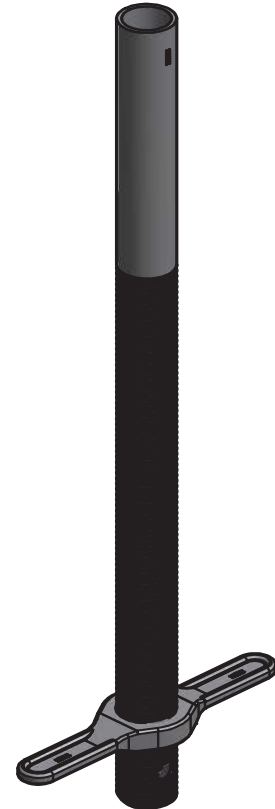
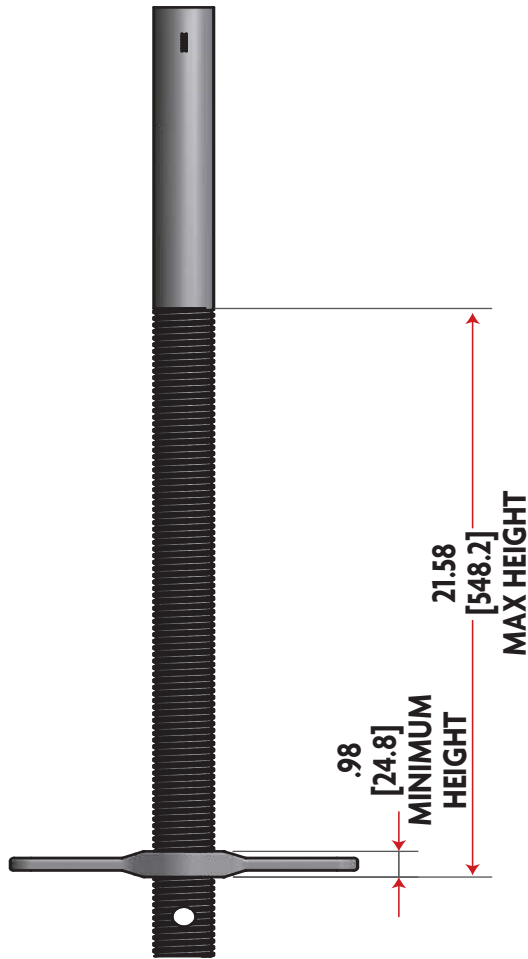

Product Code	Description	Load @ Minimum Height (lb·f)	Load @ Maximum Height (lb·f)
SHBPBJ-36	Hi-Load Screw Jack 36"	14,250	12,300

(Safe Working Loads are based on a 3:1 Safety Factor.)

World Headquarters: 6059 South Loop East | Houston, TX 77087

Offices In: California | Maryland | Hong Kong | China | United Kingdom | Latin America | Canada



SHORING FRAME ALLOWABLE WORKING LOADS

POUNDS PER LEG - SEE NOTES BELOW TABLE

NUMBER OF TIERS	Maximum Safe Working Load per leg (Lbs) - Screw Leg Extension 12"	Maximum Safe Working Load per leg (Lbs) - Screw Leg Extension 24"	Maximum Safe Working Load per leg (Lbs) - Screw Leg Extension 36"	Maximum Safe Working Load per leg (Lbs) - Screw Leg Extension 48"
1	14,400	12,400	10,000	8,500
2	13,200	11,100	9,000	8,400
3	11,600	10,800	8,600	8,200
4	10,600	9,500	8,300	8,000
5	10,200	9,100	8,000	7,700
6	10,000	8,700	7,700	7,400
7	9,900	8,600	7,300	7,200
8	9,800	8,500	7,000	7,000
9	9,700	8,400	6,750	6,750
10	9,600	8,300	6,500	6,500

Notes:

1. Tier refers to number of frames connected vertically
2. Screw leg extension is the total extension of the screws extended equally top and bottom
3. The Safety factor for allowable working loads is 2.5:1
4. Consult with an Engineer trained in shoring design for any shoring tower over 50 ft. in height

World Headquarters: 6059 South Loop East | Houston, TX 77087

Offices In: California | Maryland | Hong Kong | China | United Kingdom | Latin America | Canada

POST SHORES



SHPSHD611
6'6" - 11'6" Heavy Duty Post Shore
46.3 lbs

SHPSHD1018
10' - 18' Heavy Duty Post Shore
74.1 lbs

PART NUMBER	TESTED HEIGHT	RATED LOAD 3:1 SAFETY FACTOR
		Lbs
SHPSHD611	6'6"	7,750
	7'	7,400
	7'6"	7,050
	8'	6,700
	8'6"	6,350
	9'	6,000
	9'6"	5,650
	10'	5,300
	10'6"	4,950
	11'	4,600
11'6"	4,200	

PART NUMBER	TESTED HEIGHT	RATED LOAD 3:1 SAFETY FACTOR
		Lbs
SHPSHD1018	10'	9,900
	10'6"	9,500
	11'	9,050
	11'6"	8,625
	12'	8,200
	12' 6"	7,775
	13'	7,350
	13'6"	6,925
	14'	6,500
	14'6"	6,075
	15'	5,650
	15'6"	5,225
	16'	4,800
	16'6"	4,375
	17'	3,950
17'6"	3,525	
18'	3,100	

Based on 3:1 Safety Factor

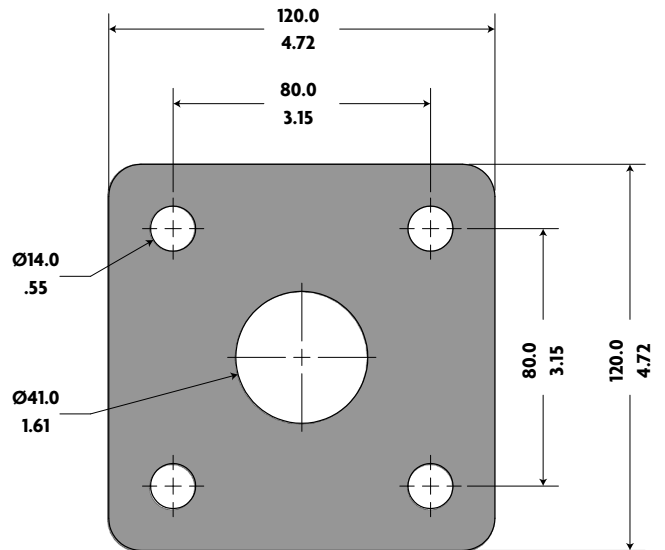

SHPSHDUH8
8" U-Head for HD Post Shore 2 Way
6.40 Lbs

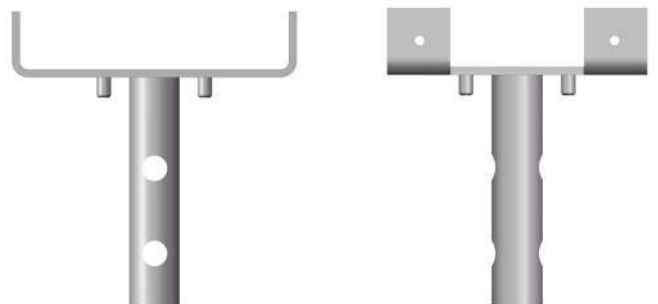

Post Shore Information

- Covers height ranges from 6'6"-18'
- Post OD 76.0mm. Wall thickness 2.6mm.
- Staff OD 63.5mm. Wall thickness 3.8mm
- HDG finish
- Quick Release Pin
- Striker/Dismantle Support
- U-head attachment optional

MEDIUM DUTY POST SHORE

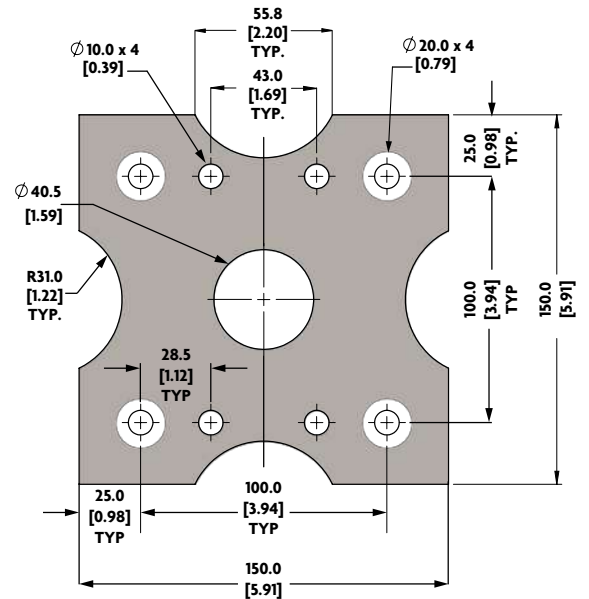
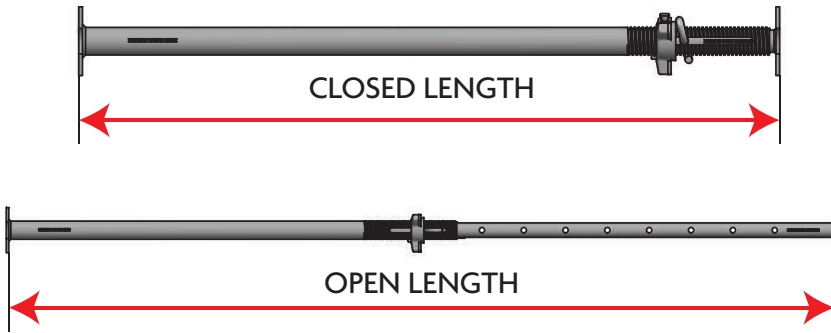

Part Number	Height for Rated Load	Rated Load Lbs 3:1	Part Number	Height for Rated Load	Rated Load Lbs 3:1	Part Number	Height for Rated Load	Rated Load Lbs 3:1	Part Number	Height for Rated Load	Rated Load Lbs 3:1
SHPS1	5'-6"	10,000	SHPS2	6'-9"	8,600	SHPS3	6'-8"	11,800	SHPS4	10'	9,100
	6'	9,550		7'	8,500		6'-9"	12,300		10'-6"	9,750
	6'-6"	9,400		7'-6"	8,300		7'	12,125		10'-9"	8,600
	7'	9,300		8'	8,000		7'-8"	9,900		11'	8,000
	7'-6"	8,700		8'-6"	7,800		8"	9,850		11'-9"	6,800
	8'	8,100		9'	7,570		8'-7"	9,750		12'	6,700
	8'-6"	7,900		9'-6"	7,300		9'	9,200		12'-6"	6,250
	9'	7,750		10'	7,000		9'-7"	9,100		12'-10"	5,650
		10'-6"	6,800	10'	8,800	13'	5,500				
				10'-6"	8,775	10'-6"	8,775	13'-6"		5,150	
				11'	7,000	11'	7,000	13'-9"		3,900	
				11'-7"	6,200	11'-7"	6,200	14'		3,860	
				12'	5,350	12'	5,350	14'-9"		3,800	
								15'		3,500	
								15'-3"		3,400	

Heavy Duty Post Shore Information

- Covers height ranges from 5'6"-15'3"
- Post OD 60.3mm. Wall thickness 3.6mm.
- Staff OD 48.3mm. Wall thickness 4mm
- HDG finish

(Safe Working Loads are based on a 3:1 Safety Factor.)

World Headquarters: 6059 South Loop East | Houston, TX 77087

Offices In: California | Maryland | Hong Kong | China | United Kingdom | Latin America | Canada

SLAB GUARDRAIL POST

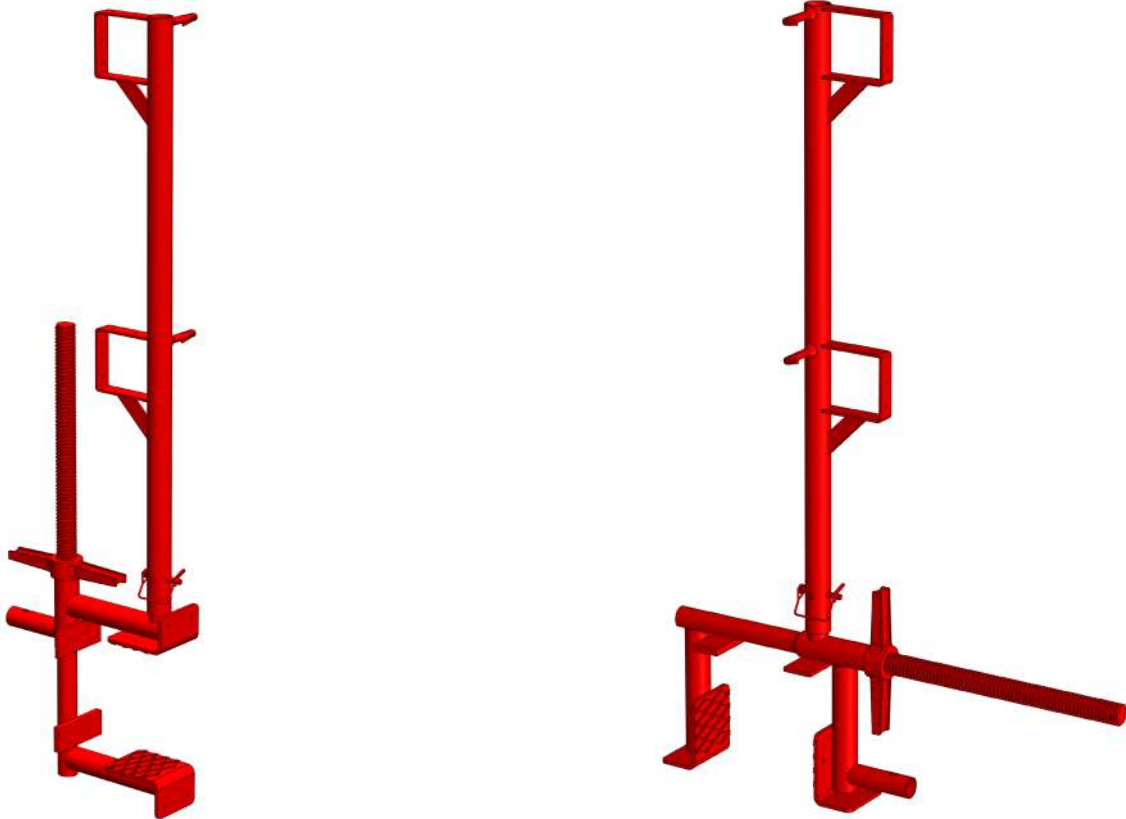

Slab Guardrail Post Information

- Works with both vertical & horizontal slabs
- Clamp adjusts from 4" to 23"
- Can be used with 2x4 lumber or tube guardrail
- Powder-Coated Red
- 24.42 lbs
- Product Code GRSL

World Headquarters: 6059 South Loop East | Houston, TX 77087

Offices In: California | Maryland | Hong Kong | China | United Kingdom | Latin America | Canada

ALUMINUM SHORING FRAMES

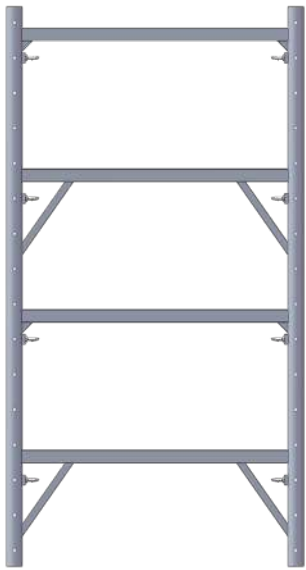

SHHLF48JL48
4'Wx8'H Aluminum Shoring Frame
48" Spacing
42.2 lbs



SHHLF46JL48
4'Wx6'H Aluminum Shoring Frame
48" Spacing
32.2 lbs

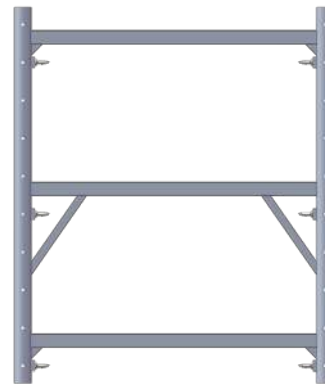

SHHLF45JL48
4'Wx5'H Aluminum Shoring Frame
48" Spacing
28.2 lbs

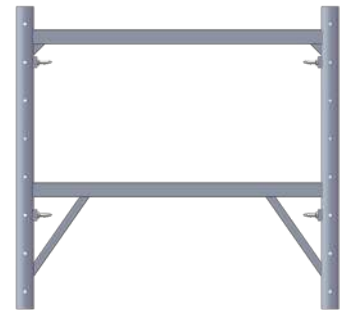

SHHLF44JL24
4'Wx4'H Aluminum Shoring Frame
24" Spacing
21.1 lbs

Aluminum Shoring Frame Information

- 2.75" (69.85mm) OD Leg Tube, 0.16" (4mm)
- Coupling Pin SHHLCP
- First lock 8.75" from top of frame leg
- Jet Lock (JL-Lock)

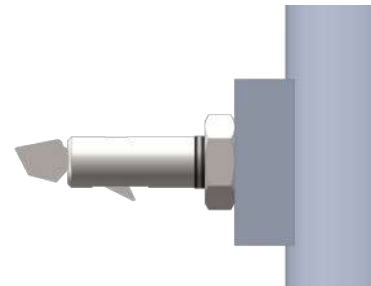

Jet Lock

ALUMINUM SHORING ACCESSORIES



SHHLUP6
6" Shaped Lock Pin
1 Lb



SHHLCP
Coupling Pin
1.21 Lbs



SHHLSJ
Screw Jack
11.20 Lbs

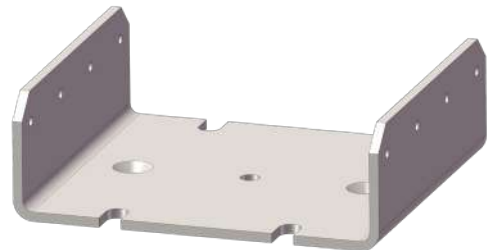

SHHLUH
8" X 9" U-Head
7.18 Lbs

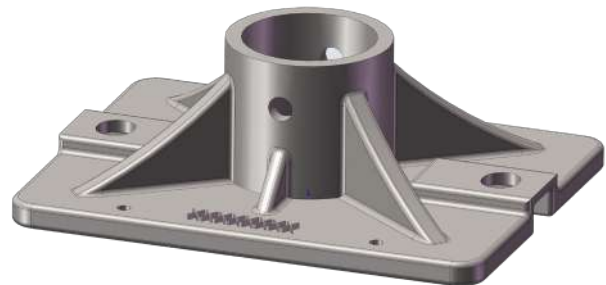

SHHLBP
Base Plate
5.28 Lbs

World Headquarters: 6059 South Loop East | Houston, TX 77087

Offices In: California | Maryland | Hong Kong | China | United Kingdom | Latin America | Canada

TUBE CROSS BRACES

1"x2mm

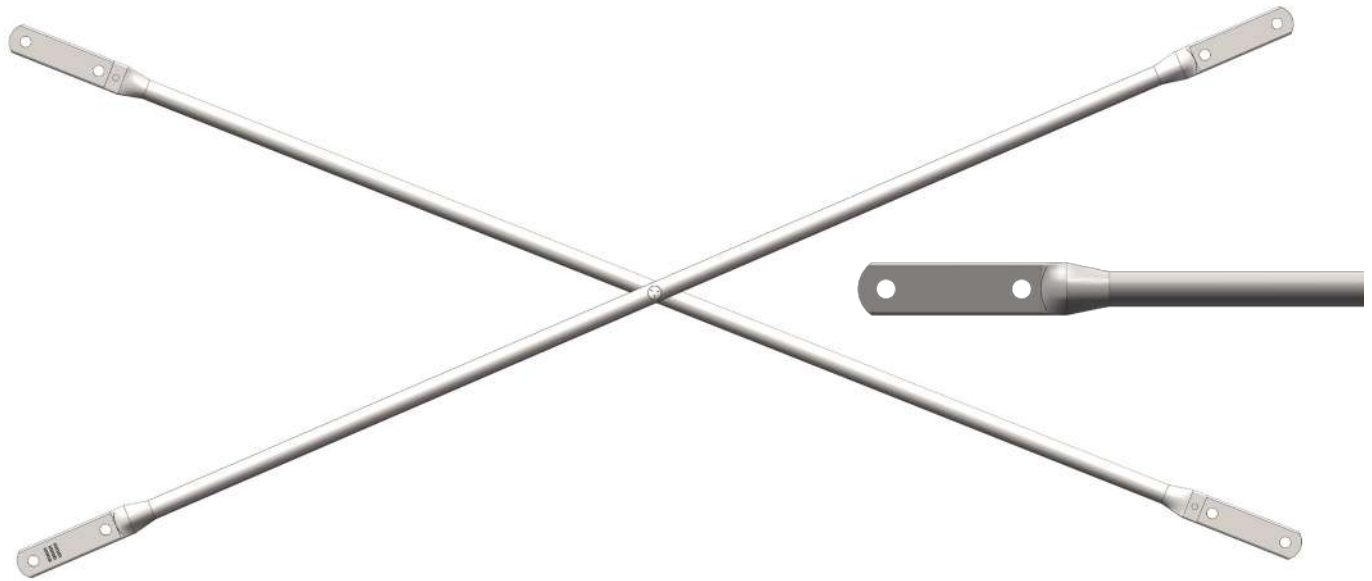

Lock Spacing	Bay Length					
	4'	5'	6'	7'	8'	10'
12"				BR0712H		BR01012H
24"	BR0424H	BR0524H	BR0624H	BR0724H	BR0824H	BR01024H
27-3/4"			BR0627H	BR0727H		BR01027H
36"	BR043648H	BR053648H	BR063648H	BR0736H	BR083648H	BR01036H
				BR073648H		BR0103648H
48"	BR043648H	BR053648H	BR063648H	BR0748H	BR083648H	BR01048H
				BR073648H		BR0103648H

CUSTOM SIZES ARE AVAILABLE UPON REQUEST. MINIMUM ORDER QUANTITY MAY APPLY.

World Headquarters: 6059 South Loop East | Houston, TX 77087

Offices In: California | Maryland | Hong Kong | China | United Kingdom | Latin America | Canada

713-673-7701 Phone | 800-720-6629 Toll Free | www.dss.net

ALUMINUM SHORING TOWER

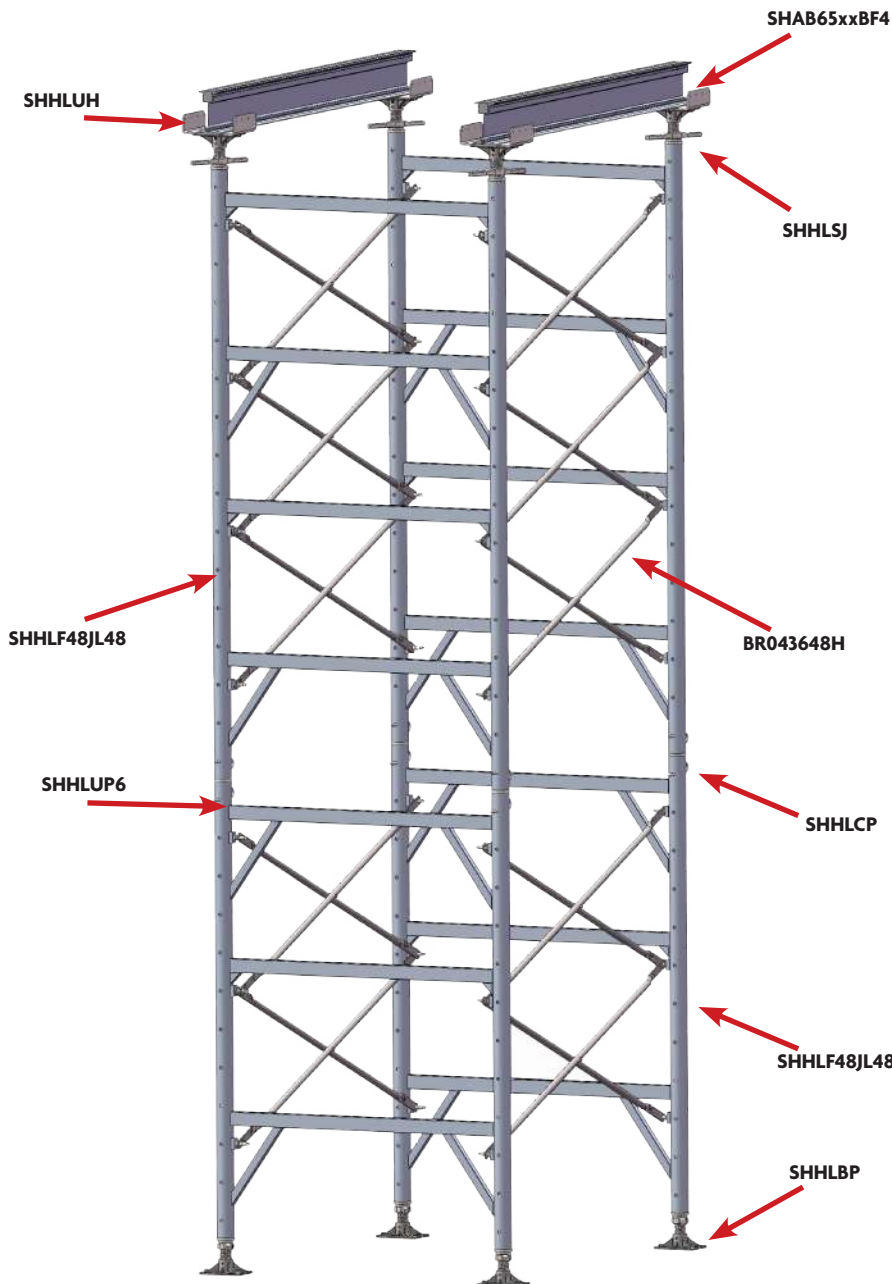

SHORING TOWER CAPACITY

A 3 tiers DSS's Shoring Tower has a Maximum Safe Working Load Capacity per leg of:

12,500 lb [55.61 kN]

These towers have been tested having screw jacks extended 12" at the top and 12" at the bottom. Safety factor 2.5:1

NOTES:

1. Tier refers to number of frames connected vertically
2. Consult with an Engineer trained in shoring design for any shoring tower over 50 ft. in height, and when lateral bracing is required.
3. DSS recommends lateral bracing for towers 3 tiers or taller. A capacity reduction for dead load should be accounted for.
4. If no suitable tying points are available, consider using other means of stabilization such as guy wires or other means as an alternative.
5. All horizontal bracing should be tied to permanent structures such as walls, columns, where possible.
6. Bracing members cannot be fixed to the frame horizontal members.
7. Fixing of lateral bracing shall be positioned at the junction of vertical legs with the bracing tube.

World Headquarters: 6059 South Loop East | Houston, TX 77087

Offices In: California | Maryland | Hong Kong | China | United Kingdom | Latin America | Canada

SHORING JACK



HALF METER OF ADJUSTMENT.

Product Code	Description	Load @ Maximum Height (lb·f)
SHHLSJ	Screw Jack w/ Nut	18,000

(Safe Working Loads are based on a 3:1 Safety Factor.)

World Headquarters: 6059 South Loop East | Houston, TX 77087

Offices In: California | Maryland | Hong Kong | China | United Kingdom | Latin America | Canada

713-673-7701 Phone | 800-720-6629 Toll Free | www.dss.net

6.5" ALUMINUM STRINGER SHAB65xxxPN

LOAD CHART

Span (ft)	Deflection (in) L/360	Load (lbs/ft) L/360	Deflection (in) L/270	Load (lbs/ft) L/270
4	0.13	3151	0.18	3151
5	0.17	2017	0.22	2017
6	0.20	1188	0.27	1188
7	0.23	748	0.31	957
8	0.27	501	0.36	668
9	0.30	352	0.40	469
10	0.33	257	0.44	342
11	0.37	193	0.49	257
12	0.40	148	0.53	198
13	0.43	117	0.58	156
14	0.47	94	0.62	125
15	0.50	76	0.67	101
16	0.53	63	0.71	84
17	0.57	52	0.76	70
18	0.60	44	0.80	59
19	0.63	37	0.84	50
20	0.67	32	0.89	43

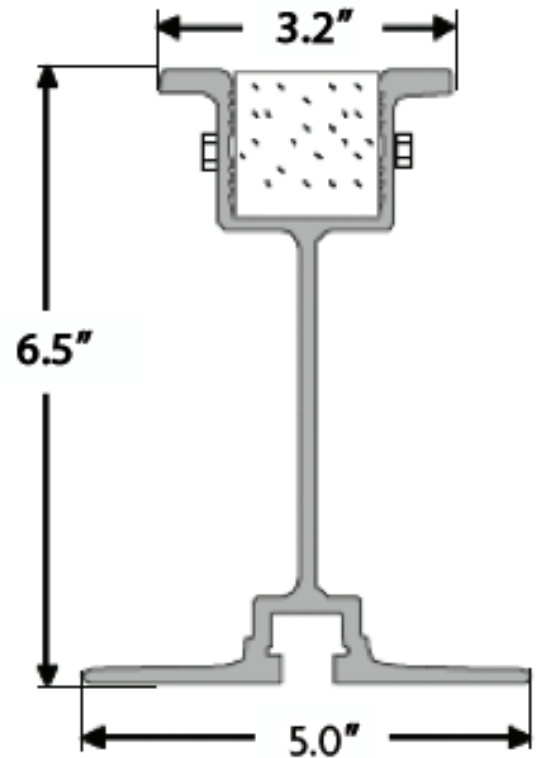

PHYSICAL SPECIFICATIONS

Overall Height	6.50 in
Base Width	5.00 in
Width, Inverted Top Hat Section	3.20 in
Cross Sectional Area (w/o nailer)	2.82 in ²
Nominal Weight (w/nailer)	4.17 lb/ft
Nominal Weight (w/o nailer)	3.32 lb/ft
Moment of Inertia (I _{xx})	17.42 in ⁴
Section Modulus, S _{xx} (min)	4.36 in ³
Modulus of Elasticity, E	10.2E6 psi

Deflection data based on simple spans.

F.O.S - 2.2 to 1. Beam to be laterally supported.

All data is provided as guidelines only.

Direct Scaffold Supply is not responsible for errors or omissions.

(Safe Working Loads are based on a 4:1 Safety Factor.)

6.5" ALUMINUM STRINGER SHAB65xxxBTF4PN

LOAD CHART

Span (ft)	Deflection (in) L/360	Load (lbs/ft) L/360	Deflection (in) L/270	Load (lbs/ft) L/270
4	0.13	3151	0.18	3151
5	0.17	2017	0.22	2017
6	0.20	1188	0.27	1188
7	0.23	748	0.31	957
8	0.27	501	0.36	668
9	0.30	352	0.40	469
10	0.33	257	0.44	342
11	0.37	193	0.49	257
12	0.40	148	0.53	198
13	0.43	117	0.58	156
14	0.47	94	0.62	125
15	0.50	76	0.67	101
16	0.53	63	0.71	84
17	0.57	52	0.76	70
18	0.60	44	0.80	59
19	0.63	37	0.84	50
20	0.67	32	0.89	43

PHYSICAL SPECIFICATIONS

Overall Height	6.50 in
Base Width	4.00 in
Width, Inverted Top Hat Section	3.20 in
Cross Sectional Area (w/o nailer)	2.52 in ²
Nominal Weight (w/nailer)	4 lb/ft
Nominal Weight (w/o nailer)	3.15 lb/ft
Moment of Inertia (I _{xx})	15.91 in ⁴
Section Modulus, S _{xx} (min)	4.35 in ³
Modulus of Elasticity, E	10.2E6 psi

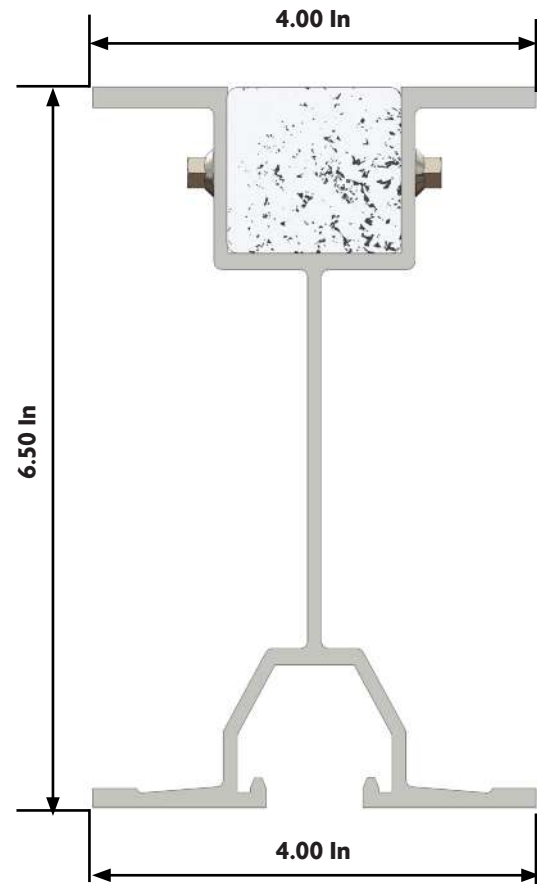

Deflection data based on simple spans.

F.O.S - 2.2 to 1. Beam to be laterally supported.

All data is provided as guidelines only.

Direct Scaffold Supply is not responsible for errors or omissions.

(Safe Working Loads are based on a 4:1 Safety Factor.)

7.5" ALUMINUM STRINGER SHAB75xxPN

LOAD CHART

Span (ft)	Deflection (in) L/360	Load (lbs/ft) L/360	Deflection (in) L/270	Load (lbs/ft) L/270
4	0.13	4149	0.18	4149
5	0.17	3319	0.22	3319
6	0.20	2373	0.27	2581
7	0.23	1494	0.31	1896
8	0.27	1001	0.36	1335
9	0.30	703	0.40	937
10	0.33	512	0.44	683
11	0.37	385	0.49	513
12	0.40	297	0.53	395
13	0.43	233	0.58	311
14	0.47	187	0.62	249
15	0.50	152	0.67	202
16	0.53	125	0.71	167
17	0.57	104	0.76	139
18	0.60	88	0.80	117
19	0.63	75	0.84	100
20	0.67	64	0.89	85

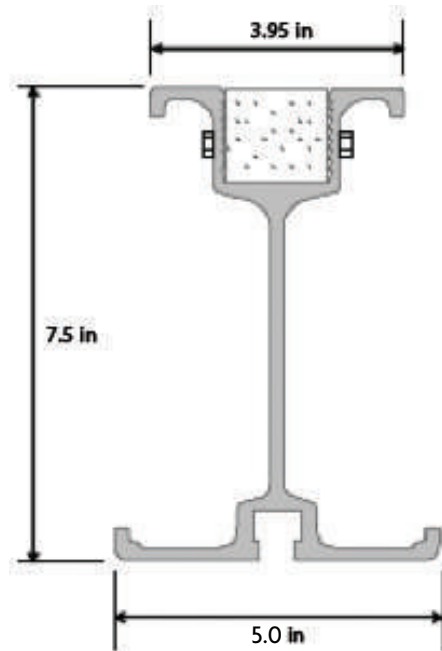

PHYSICAL SPECIFICATIONS

Overall Height	7.50 in
Base Width	5.00 in
Width, Inverted Top Hat Section	3.95 in
Cross Sectional Area (w/o nailer)	4.0 in ²
Nominal Weight (w/nailer)	5.8 lb/ft
Moment of Inertia (I _{xx})	34.25 in ⁴
Section Modulus, S _{xx} (min)	8.76 in ³
Modulus of Elasticity, E	10.1E6 psi

Deflection data based on simple spans.

F.O.S - 2.2 to 1. Stringers to be laterally supported.

All data is provided as guidelines only.

Direct Scaffold Supply is not responsible for errors or omissions.

(Safe Working Loads are based on a 4:1 Safety Factor.)

7.25" DOUBLE FLANGE STRINGER SHAB725xxxPN

LOAD CHART

Span (ft)	Deflection (in) L/360	Load (lbs/ft) L/360	Deflection (in) L/270	Load (lbs/ft) L/270
4	0.13	5194	0.18	5194
5	0.17	3324	0.22	3324
6	0.20	1988	0.27	2308
7	0.23	1252	0.31	1669
8	0.27	839	0.36	1118
9	0.30	589	0.40	785
10	0.33	429	0.44	572
11	0.37	323	0.49	430
12	0.40	249	0.53	331
13	0.43	195	0.58	261
14	0.47	156	0.62	209
15	0.50	127	0.67	170
16	0.53	105	0.71	140
17	0.57	87	0.76	117
18	0.60	74	0.80	98
19	0.63	63	0.84	83
20	0.67	54	0.89	72

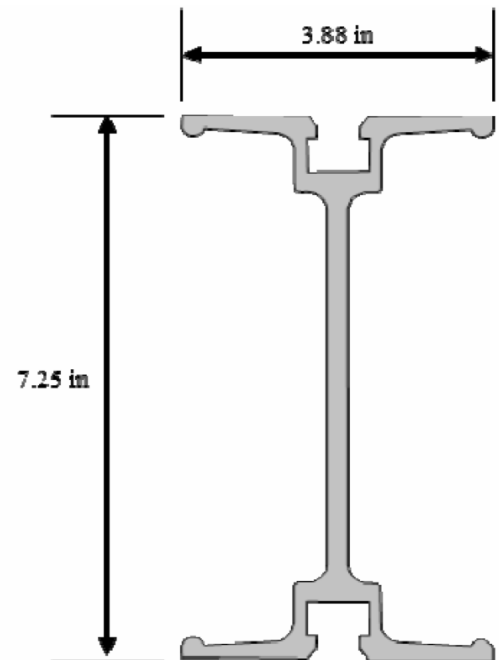

PHYSICAL SPECIFICATIONS

Overall Height	7.25 in
Flange Width (both)	3.9 in
Cross Sectional Area	3.65 in ²
Nominal Weight	4.4 lb/ft
Moment of Inertia (I _{xx})	28.41 in ⁴
Section Modulus, S _{xx} (min)	7.84 in ³
Modulus of Elasticity, E	10.2E6 psi

Deflection data based on simple spans.

F.O.S - 2.2 to 1. Stringers to be laterally supported.

All data is provided as guidelines only.

Direct Scaffold Supply is not responsible for errors or omissions.

(Safe Working Loads are based on a 4:1 Safety Factor.)